



Product Catalog

Strength Through Innovation Since 1764



CORE VALUES

SAFETY
•
RELIABILITY
•
INNOVATION

Company Information & Services

About our Products • Global Presence • Training

1

Sling Components

Grade 10 • Offshore • Grade 8 • Hot Dip Galvanized

2

Lifting Points

Rotating • De-centered • Ball-bearing • Weldable • Screw-on

3

Shackles & Rigging Screws

Dee and Bow Shackles • Arctic Shackles • Aquaculture • Stainless Steel Shackles

4

Chain

Grade 10 • Grade 8 • Short Link • Mid-link • Long-link

5

Lashing Components

Chain Tensioner • Other Lashing Products

6

WARNING:

Failure to read, understand and comply with the instructions, working load limits and specifications in this publication may result in serious injury or damage to property.

Where there is growth and development in the world...



...Gunnebo Industries products can be found.

Company Information and Services

About our products	1:6 - 1:7
Global presence	1:8
Quality, technology & innovation	1:9
Training	1:10 - 1:11



A legacy of innovation

In 1764 Hans Hultman founded Gunnebo Industries in the shape of a hammer-smithy in Småland, Sweden.

Gunnebo Industries was acquired by The Crosby Group in 2019, and as a group we continuously drive innovation through product development to create the optimal solutions for each lifting situation. Since the early 1950's we have developed products that are today's standards on the market and copied by almost all manufacturers of lifting equipment.

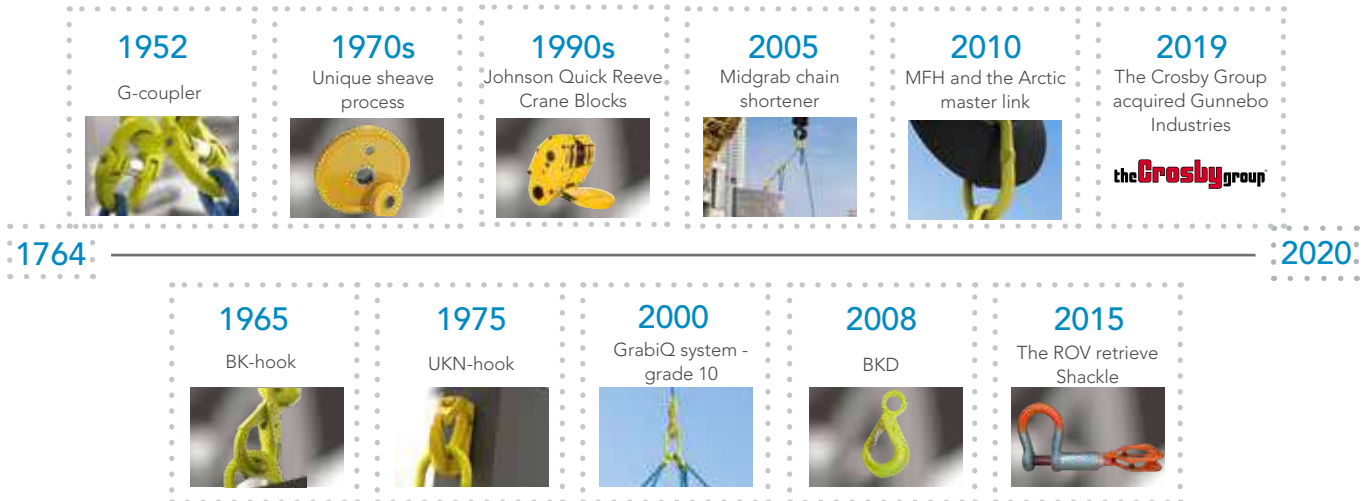

Unique quality process for our chain & lifting components

Traceability code

The traceability code consists of letters and numbers that identifies exactly which plant the product was made in, the year and the batch. This gives us the ability to trace the product back through the manufacturing process, all the way back to the specific raw material.

Approved by BG/DGUV

Our products have the H32-stamp which means that they are manufactured and approved in accordance to the rules of Die Berufsgenossenschaft Handel und Warenlogistik (BGHW). This is a proof of quality and ensures that the product contributes to the safest possible working environment for both personnel and load.

Quality assurance

All forged parts and every chain link are individually proof loaded during our manufacturing process.

Manufacturer name

All our forged components are marked with "Gunnebo Sweden".

Component type, size and grade

The size and grade is clearly marked on each component, to avoid errors and ensures correct matching of chain and components.

High quality steel

Our components and chain are made only from steel from European suppliers with 100% traceability and quality assurance.



Wide range of products and applications

1



Chain & Lifting Components

Our chain and components are made from special hardened and tempered alloy steel that guarantees high strength, low weight, high wear resistance and long life. All components are uniformly marked with chain size, grade, manufacture's designation and name. Every forged component is tested to the Manufacturing Proof Force before leaving our factories in Sweden.



The GrabiQ System

Our GrabiQ Grade 10 range features integral shortening, reduced number of components and more flexible use of chain slings. This provides a modular concept for cost effective lifting solutions that covers a wide set of applications.



Lifting Points

Our wide range of lifting points allow us to provide complete solutions developed for each customer's needs, enabling improved operational efficiency for our customers. All of our Lifting Points are CE marked. Each lifting point has been proof loaded to 2.5 times the Working Load Limit and visually inspected by a licensed inspector before leaving the factory.



Shackles & Rigging Screws

Our shackles are available in a broad range of steel including acid proof stainless steel and high grade alloy steel to comply with the most stringent specifications. Several of our shackles are also Type Approved to DNV 2.7-1. The production of shackles and rigging screws takes place in our factory located outside Bergen, Norway.

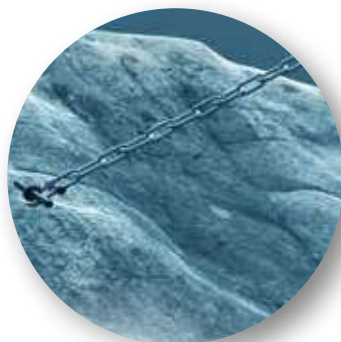

Aquaculture

Our maritime products are made for a life under water. For example, our Hot Dip Galvanized (HDG) lifting range is designed to meet the specific challenges from corrosive environments in which they will have a longer lifetime. In the long run our HDG products require less maintenance and are more cost effective.



Arctic Offshore

Adverse weather and rough sea conditions, sometimes in combination with extremely low temperatures, must be considered in the design of offshore lifting sets. Our offshore range is produced from steel that gives improved impact strength at low operating temperatures, as well as reduced risk for hydrogen embrittlement.

Global presence

The Crosby Group has a global footprint with manufacturing sites across North America & Europe and distribution partners in more than 50 countries.



Our global team consists of over 1,400 employees

Quality, technology & innovation

Outstanding quality level

- Gunnebo Industries environmental and quality management system is certified according to ISO 14001:2015 and ISO 9001:2015.
- A number of different third-party product certificates including DNV type approvals for our offshore master links and hooks.
- Full traceability and individual proof-loading to 200-250% of the working load limit of all forged parts and chain links.
- Extensive testing and inspection process.

World-class manufacturing process

- Automated state-of-the-art production sites.
- Fully integrated manufacturing process with all critical processes in-house.
- Full traceability from finished product to raw material.

Technical expertise

- System design creating operational efficiency through time and weight savings, as well as increased flexibility.
- Design expertise and outstanding customer service.
- Our own R&D department.

Heritage of innovation

- Many of the products that are today's industry standard have been developed by Gunnebo Industries, with innovation since 1764.



Training



Knowledge lifts loads off your mind

We want to ensure that you have safe and correct handling of our products. In order to do so, we have developed a number of customer training programs. The courses are presented by our highly qualified staff, often at site together with customers.

We offer a range of training sessions that will increase both your knowledge of our products and how to handle them safely and correctly, as well as give you sales hints on selling in a very competitive market.

Our technical courses will not only help to create a safer working environment, but also increase the life span of our products.

After successful completion of the course, each participant will receive a Certificate, detailing the knowledge achieved.

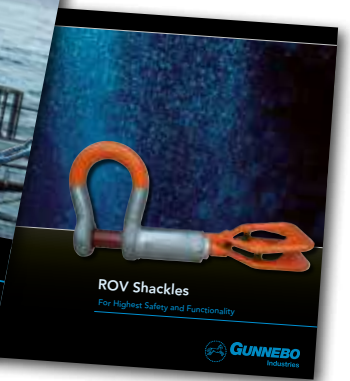

Target groups for Gunnebo Industries courses are:

- Gunnebo Industries distributors
- Purchasing personnel
- Safety personnel
- Rigging supervisors
- Users of Rigging

Training courses

Technical training

Level 1	1 day	<ul style="list-style-type: none"> • Company information • Current relevant legislation • Lifting equipment selection • Sling configuration including the GrabiQ system • Gunnebo Industries products • Shackle program • Blocks and sheaves program
---------	-------	---

Level 2	2 days	<ul style="list-style-type: none"> • More detailed Level 1 information • Safe use of lifting equipment • Gunnebo manufacturing process • Practical handling and sling assembly • Inspection and maintenance
---------	--------	--

Sales training

	Half day	<ul style="list-style-type: none"> • Company information • Sales training • Sales promotion methods • Practical tips on technical sales
--	----------	---

Training locations

- Gunnebo Industries global subsidiaries
- Gunnebo Industries main distributor centres
- On-site at suitable training centres

Post course information service

All participants can also request technical advice and information from instructor after completion of the course.

Course dates and schedules

For more information and course dates, please contact us at export@gunneboindustries.com or contact any of our sales teams.

Sling Components

Grade 10 • Offshore • Grade 8 • Hot Dip Galvanized



GrabiQ (grade 10)

GrabiQ System	2:2 - 2:3
FlexiLeg	2:4
GrabiQ Solutions	2:5 -2:6
Pre-Assembled Chain Sling	2:7
Midgrab Chain Shortener MIG	2:8
Master Links	2:9 - 2:11
Coupling Link G	2:11
C-Grab	2:12
C-Lok	2:12
Chain	2:13
Grab Hooks	2:14
Safety Hooks Clevis	2:15
Safety Hooks Eye	2:15 - 2:17
Safety Hook Shank	2:17
Safety Hooks Swivel	2:18
Sling Hooks Clevis	2:19
Sling Hook Eye	2:19
Foundry Hook OKE	2:20
Swivel Latch Hooks	2:20
Round Sling Hook RH	2:21
Container Hook CH	2:21
Chain Tensioner GT for lifting	2:21

Offshore

Master Links Offshore	2:24 - 2:25
Safety Hooks Offshore	2:26
Double Latch Hook Offshore	2:26
WRIN STR Safety Handle	2:27

Classic (grade 8)

SK-system	2:29
SK Products	2:30 - 2:31
Universal Weld-on Hook	2:32
Master Links	2:33
Coupling Link	2:33
Berglok Chain Coupler BL	2:34
Chain	2:34
Grab Hook OG	2:34
Safety Hooks	2:35 - 2:36
Sling Hooks	2:35 - 2:36
Container Hook	2:35
Swivel Safety Hooks	2:36
Clevis Shackle GSA	2:37
Clevis Egglink CEL	2:37
Foundry Hook OKE	2:37
Coupling Link GF Stainproof	2:37

Hot Dip Galvanized (grade 8)

Master Link MF HDG	2:39
Chain KLZ HDG	2:39
Safety Hook BK HDG	2:39
Swivel Safety Hook BKL HDG	2:39
Coupling Link G HDG	2:39

Spare Parts

Spare Parts	2:40 - 2:44
-------------	-------------

Technical Information

Safe use and maintenance	2:45
Quality assurance	2:46
Working Load Limits	2:47 - 2:49

WARNING:
Failure to read, understand and comply with the instructions, working load limits and specifications in this publication may result in serious injury or damage to property.

GrabiQ system for increased efficiency and reduced cost

Our GrabiQ chain sling system for coupling, shortening and lifting in grade 10 is designed to integrate multiple functions in each component.

GrabiQ – Quicker, safer and easier lifting operations

- **Intelligent design:**
Efficient and ergonomic lifts.
- **Multiple functions in each component:**
Fewer components in each sling, resulting in cost effective lifting operations.
- **Built in shortening function:**
Allows the user to instantly adjust the chain sling.
- **Grade 10:**
Lighter slings and 25 % added strength compared to grade 8.
- **High quality:**
All products are proof loaded and visually inspected.

GrabiQ components with multiple functions

Innovative designs that combines several clever functions in one component.



2

Midgrab - MIG

- Instant mounting, positioning, shortening on any part of the chain.

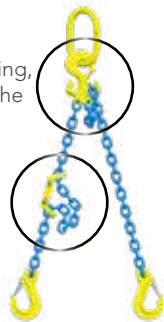

C-grab Duo - CGD

- Built in shortening function.



Master Grab - MG

- "All-in-one" compact top link
- Every chain leg can instantly be altered.
- Using the built in shortening function you can alter between a straight lift to a looped sling in a matter of seconds.

Fewer components with GrabiQ

With GrabiQ the number of components and the weight is significantly reduced:

4-leg sling with shortening function



- 1 Master link
- 2 C-Grab Duo

Total:
3 GrabiQ components



- 1 Master link with 2 Sublinks
- 8 Berglok Chain Couplers
- 4 Grab Hooks

Total:
15 components

2-leg sling with shortening function



- 1 Master Grab Duo

Total:
1 GrabiQ component



- 1 Master link
- 4 Berglok Chain Couplers
- 2 Grab Hooks

Total:
7 components

Less is more with FlexiLeg™

Thanks to the unique features of our GrabiQ product range we can offer solutions that increase the flexibility in lifting operations even further. Our FlexiLeg solution allows you to have an instant leg change onsite. With one single master link in combination with five Flexi-legs we offer a solution that replaces four complete traditional slings, a total of ten legs. In addition to this Flexi-leg also gives you the opportunity to modify the chain sling to different lifting operations, whenever and wherever it is needed.

The benefits of instant leg-change

- It enables the user to change slings, leg by leg.
- It makes the sling lighter and easier to work with.
- Sling legs that are not being used can easily be removed, thereby increasing safety at the work site.
- The quantity of sling material is greatly reduced, providing cost savings.
- The chain sling can be rebuilt on site, thus increasing efficiency.



GrabiQ FlexiLeg – a total of 5 legs replaces the total of 10 legs with the old traditional system.

GrabiQ™



1 - Leg

+



2 - Leg

+



3 - Leg

+

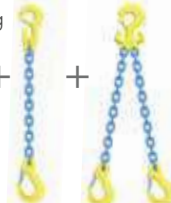

4 - Leg

+

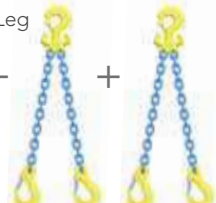

Traditional system

1 - Leg



2 - Leg



3 - Leg



4 - Leg



Related products

QuickPin for safe exchange of sling legs

- Fits all C-components (CL, CLD, CG, CGD)
- Has instant close/open function, no tools needed
- Easy to retro-fit
- Made of stainless steel for long product life span

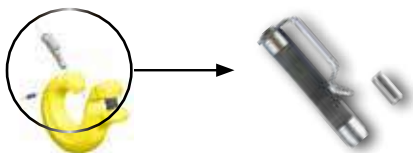

FlexiTag for every GrabiQ sling

- Specially designed for FlexiLeg
- Fits all other GrabiQ slings
- WLL and chain size pre-stamped for 1 - 4 legs
- Leg angle 45/60 degree shown in contour
- Made of stainless steel for use in all weather conditions



GrabiQ solutions for every need

1-leg Chain slings



MG1-GBK
Consist of: Master link MG,
Chain KLA, Safety Hook GBK

Dim. mm	WLL t*	Total Components length, mm
6	1.5	171
8	2.6	296
10	4.0	361
13	6.8	453
16	10.3	527



MG1-EGKN
Type: Master link MG, Chain KLA,
Hook with latch EGKN

Dim. mm	WLL t*	Total Components length, mm
6	1.5	231
8	2.6	261
10	4.0	331
13	6.8	408
16	10.3	481



TG1-GBK
Master link MF, C-grab CG,
Chain KLA, Safety Hook GBK

Dim. mm	WLL t*	Total Components length, mm
6	1.5	200
8	2.6	346
10	4.0	424
13	6.8	504
16	10.3	621

2

2-leg Chain sling



TG1-EGKN
Consists of: Master link MF, C-grab CG,
Chain KLA, Hook with latch EGKN

Dim. mm	WLL t*	Total Components length, mm
6	1.5	286
8	2.6	342
10	4.0	415
13	6.8	507
16	10.3	624



MGD2-EGKN
Consists of: Master link MGD,
Chain KLA, Latch Hook EGKN

Dim. mm	WLL tonnes*		Total Components length, mm
	β 0-45° α 0-90°	β 45-60° α 90-120°	
6	2.1	1.5	230
8	3.5	2.6	261
10	5.6	4.0	331
13	9.5	6.8	408
16	14.0	10.3	481



MGD2-GBK
Consists of: Master link MGD,
Chain KLA, Safety Hook GBK

Dim. mm	WLL tonnes*		Total Components length, mm
	β 0-45° α 0-90°	β 45-60° α 90-120°	
6	2.1	1.5	235
8	3.5	2.6	296
10	5.6	4.0	361
13	9.5	6.8	453
16	14.0	10.3	527



TG2-GBK
Consists of: Master link MF, C-grab Duo CGD,
Chain KLA, Safety Hook GBK

Dim. mm	WLL t*		Total Components length, mm
	β 0-45° α 0-90°	β 45-60° α 90-120°	
6	2.1	1.5	291
8	3.5	2.6	366
10	5.6	4.0	444
13	9.5	6.8	534
16	14.0	10.3	671



TG2-EGKN
Consists of: Master link MF, C-grab Duo CGD,
Chain KLA, Latch Hook EGKN

Dim. mm	WLL t*		Total Components length, mm
	β 0-45° α 0-90°	β 45-60° α 90-120°	
6	2.1	1.5	286
8	3.5	2.6	342
10	5.6	4.0	415
13	9.5	6.8	507
16	14.0	10.3	625



MGD2-CL
Consists of: Master link MGD,
Chain KLA, C-lok CL

Dim. mm	WLL t*		WLL choked t*		Total Components length, mm
	β 0-45° α 0-90°	β 45-60° α 90-120°	β 0-45° α 0-90°	β 45-60° α 90-120°	
6	2.1	1.5	1.6	1.2	187
8	3.5	2.6	2.7	2.0	230
10	5.6	4.0	4.4	3.2	285
13	9.5	6.8	7.4	5.4	359
16	14.0	10.3	11.0	8.0	429

Based on EN 818-4:2008 WLL + 25%

*Safety factor 4:1

See 3- and 4-leg GrabiQ solutions on next page >>>

3-leg Chain sling



TG3-GBK

Consists of: Master link MF, C-grab CG, C-grab Duo CGD, Chain KLA, Safety Hook GBK

Dim. mm	WLL t*		Total component length mm
	β 0-45° α 0-90°	β 45-60° α 90-120°	
6	3.1	2.2	311
8	5.2	3.7	392
10	8.4	6.0	474
13	14.0	10.0	604
16	21.0	15.0	680



TG3-EGKN

Consists of: Master link MF, C-grab CG, C-grab Duo CGD, Chain KLA, Latch Hook EGKN

Dim. mm	WLL t*		Total Component length mm
	β 0-45° α 0-90°	β 45-60° α 90-120°	
6	3.1	2.2	306
8	5.2	3.7	357
10	8.4	6.0	444
13	14.0	10.0	559
16	21.0	15.0	634

4-leg Chain sling



TG4-GBK

Consists of: Master link MF, C-grab Duo CGD, Chain KLA, Safety Hook GBK

Dim. mm	WLL t*		Total Component length mm
	β 0-45° α 0-90°	β 45-60° α 90-120°	
6	3.1	2.2	311
8	5.2	3.7	392
10	8.4	6.0	474
13	14.0	10.0	604
16	21.0	15.0	680



TG4-EGKN

Consists of: Master link MF, C-grab Duo CGD, Chain KLA, Latch Hook EGKN

Dim. mm	WLL t*		Total Component length mm
	β 0-45° α 0-90°	β 45-60° α 90-120°	
6	3.1	2.2	306
8	5.2	3.7	357
10	8.4	6.0	444
13	14.0	10.0	559
16	21.0	15.0	634

WLL tonnes Grade 10 GrabiQ

Based on EN 818-4:2008 WLL + 25%

Sling type	1-leg		2-leg		3- and 4-leg		Choke Hitch	
	Condition of use	β 0-45° α 0-90°	β 45-60° α 90-120°	β 0-45° α 0-90°	β 45-60° α 90-120°	Choke β 0-45° α 0-90°	Choke β 45-60° α 90-120°	
Load factor	1	1.4	1	2.1	1.5	1.1	0.8	
Chain size								
6	1.50	2.10	1.50	3.10	2.20	1.60	1.20	
7	1.95	2.70	1.95	4.00	2.90	2.10	1.50	
8	2.50	3.50	2.50	5.20	3.70	2.70	2.00	
10	4.00	5.60	4.00	8.40	6.00	4.40	3.20	
13	6.80	9.50	6.80	14.20	10.20	7.40	5.40	
16	10.00	14.10	10.00	21.00	15.00	11.00	8.00	
20	16.00	22.50	16.00	33.60	24.00	17.60	12.80	
22	20.00	28.20	20.00	42.00	30.00	22.00	16.00	
26	27.00	38.00	27.00	56.70	40.50	29.70	21.60	
32	40.00	56.40	40.00	84.00	60.00	44.00	32.00	

Safety factor 4:1. Working load limits are based upon equally loaded and disposed sling legs.

Pre-assembled GrabiQ chain sling

Ready to use at arrival

Gunnebo Industries offers the perfect retail solution - pre-assembled chain slings with information tags, supplied with certificate, packed in boxes. Ready to be used the instant they arrive.



Technical specification

CE

Art. no.	Code	WLL tonnes*	Length m	Choked WLL	Weight kg	
B790110	MG1-GBK-6-10	1.5	2	-	4.1	
B790111	MG1-GBK-8-10	2.6	3	-	6.4	
B790112	MG1-GBK-10-10	4.0	3	-	10.1	
B790120	MG1-EGKN-6-10	1.5	2	-	2.8	
B790121	MG1-EGKN-8-10	2.6	3	-	6	
B790122	MG1-EGKN-10-10	4.0	3	-	9.7	
B790220	MG2-EGKN-6-10	2.1	2	-	7.1	
B790221	MG2-EGKN-8-10	3.5	3	-	11.7	
B790222	MG2-EGKN-10-10	5.6	3	-	17.6	
B790210	MG2-GBK-6-10	2.1	2	-	7.3	
B790211	MG2-GBK-8-10	3.5	3	-	12.3	
B790212	MG2-GBK-10-10	5.6	3	-	18.9	
B790130	MG2-CL-6-10	2.1	6	1.6	12.4	
B790131	MG2-CL-8-10	3.5	6	2.7	21.8	
B790132	MG2-CL-10-10	5.6	6	4.4	34.9	

2

FlexiLeg

CE

Art. no.	Code	WLL in tonnes*		
		1-leg	2-leg	3- & 4-leg
Z101050	FlexiLeg GBK 6 mm L= 2 m	1.5	2.1	3.15
Z101051	FlexiLeg EGKN 6 mm L= 2 m	1.5	2.1	3.15
Z101052	FlexiLeg GBK 8 mm L= 2 m	2.6	3.5	5.2
Z101053	FlexiLeg EGKN 8 mm L= 2 m	2.6	3.5	5.2
Z101054	FlexiLeg GBK 10 mm L= 2 m	4.0	5.6	8.4
Z101055	FlexiLeg EGKN 10 mm L= 2 m	4.0	5.6	8.4
Z101056	FlexiLeg GBK 13 mm L= 2 m	6.8	9.5	14
Z101057	FlexiLeg EGKN 13 mm L= 2 m	6.8	9.5	14
Z101058	FlexiLeg GBK 16 mm L= 2 m	10.3	14	21
Z101059	FlexiLeg EGKN 16 mm L= 2 m	10.3	14	21

* For different lifting angles - see WLL table page 2:5 - 2:6.

Pre-assembled 6 mm FlexiLeg

CE

Art. no.	Code	Weight kg
Z101016	FlexiLeg FMG 221 GBK 6 mm L= 2 m	13.8
Z101017	FlexiLeg FMG 221 EGKN 6 mm L= 2 m	13.3



Midgrab chain shortener MIG

Product features

- Instant mounting and positioning on any part of the chain.
- Shortening in either chain direction; up-down.
- Designed to prevent inadvertent chain disengagement.
- Can be set idle on the chain leg when shortening is not required.
- LC version offers secure mounting with locking set on any desired part of the chain with one chain direction open for shortening.
- CC version offers close-open function in both chain directions for safe retention of the chain.



Locking devices for Midgrab MIG

Note! The MIG should be used with at least one locking device.

L - fixed locking set

For fixed mounting

Code:

L-8: B14905

L-10: B14915

L-13: B14917



C - close/open locking set

Spring operated locking device. Can be placed either in open or closed position.

Code:

C-8: B14904

C-10: B14914

C-13: B14916



Product code guide - locking options



MIG C



MIG CC



MIG L



MIG LC

MIG with C pins

Art. no.	Code	WLL tonnes*	L	X	Y	Weight kg
B14303	MIG CC-8-10	2.6	95	50	60	0.7
B14313	MIG CC-10-10	4.0	125	70	77	1.1
B14323	MIG CC-13-10	6.8	150	90	80	2.6

MIG without pins

Art. no.	Code	WLL tonnes*	L	X	Y	Weight kg
B14300	MIG-8-10	2.6	95	50	60	0.6
B14310	MIG-10-10	4.0	125	70	77	1.0
B14320	MIG-13-10	6.8	150	90	80	2.5

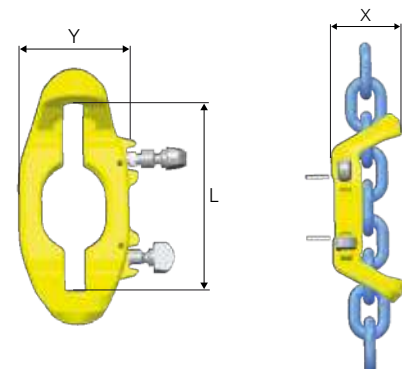

Identification of our Master Links

To provide good readability and traceability our master links have the following marking:

Product type

- M - represents single type master link.
- MT - represents master link assembly.
- OS - is an abbreviation for offshore. All Arctic offshore master links are marked with OS and complies with DNV 2.7-1.

Size designation

- The size is linked to the WLL as well as to compatible products, like attachment links and other components.
- Trade size.
- The size expressed in inch.

Approved by BG/DGUV

- H32 – represents Gunnebo Industries' manufacturing ID. The ID also represents a 3rd part audit by BGHW in Germany.

Traceability code

- The traceability code is unique for the production batch and normally consists of a letter and a number; for example A2. The traceability code makes it possible to trace and track the product through the whole production process back to the raw material used for the actual product.

Gunnebo Sweden

- To clearly highlight the Gunnebo Industries brand, our master links are marked with Gunnebo Sweden.

Meets the standards

- The markings fulfills the requirements of EN 1677-4, ASTM A952/A952M-02, AS 3775.2 and DNV 2.7-1.

2



Master Link M

Art. no.	Code	WLL tonnes (SF 5:1)		L	E	D	Weight kg
		EN 1677-4	A952/A952M AS 3775.2				
Z101271	M-6-10	1.5	1.5	100	60	11	0.2
Z101272	M-86-10	2.5	3.2	125	70	14	0.4
Z101273	M-108-10	4.0	5.2	140	80	17	0.8
Z101274	M-13-10	6.8	6.8	150	90	19	1.0
Z101267	M-1310-10	7.5	8.0	160	95	22	1.5
Z101268	M-1613-10	10.0	13.6	190	110	28	2.8
Z101247	M-19-10	12.0	16.0	200	120	30	3.5
Z101269	M-2016-10	17.0	20.6	240	140	34	5.2
Z101270	M-2220-10	25.0	30.9	250	150	40	7.3
Z101275	M-2622-10	28.0	35.0	250	150	42	8.7
Z101284	M-32-10	33.0	38.6	300	180	45	11.7
Z101276	M-3226-10	43.0	46.6	300	200	50	14.8
Z101277	M-3632-10	56.0	65.0	350	200	55	20.7
Z101278	M-4536-10	70.0	72.7	375	210	60	26.4
Z101279	M-90T-10	90.0	100.0	450	250	70	42.8
Z101280	M-125T-10**	125.0	125.0	450	260	80	57.0

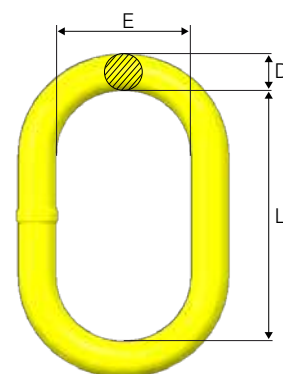

** Dimension L and E not acc. to EN 1677-4.

Fulfills requirements in: EN 1677:2008 (WLL +25%), ASTM A952/A952M-02, AS 3775:2014 and AS 3776:2015.

Master Link MF

For 1-, 2-, 3- and 4-leg slings. Designed for use with CL, CLD, CG and CGD. 3- and 4 leg chain slings require CLD / CGD.

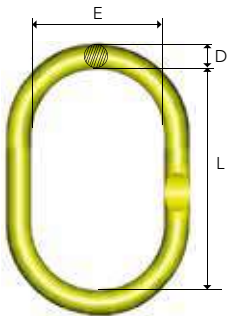

Art. no.	Code	WLL tonnes (SF 5:1)		For chain size, mm			L	E	D	Weight kg
		EN 1677-4	A952/A952M AS 3775.2	1-leg	2-leg	3-4-leg				
B14487	MF-6-10	1.5	1.5	6			100	60	11	0.2
B14481	MF-86-10	2.5	3.2	6, 8	6	-	125	70	14	0.4
B14482	MF-108-10	4.0	5.2	10	8	6	140	80	17	0.8
B14483	MF-1310-10	7.5	8.0	13	10	8	160	95	22	1.5
B14484	MF-1613-10	10.0	13.6	16	13	10	190	110	28	2.8
B14485	MF-2016-10	17.0	20.6	20	16	13	240	140	34	5.2
B14486	MF-2220-10	25.0	30.9	22	20	16	250	150	40	7.3

Fulfills requirements in: EN 1677:2008 (WLL +25%), ASTM A952/A952M-02, AS 3775:2014 and AS 3776:2015.

Master Link MFH

Designed for crane hooks, DIN 15401 and 15402. Designed for use with CL, CLD, CG and CGD. 3- and 4 leg chain slings require CLD / CGD.

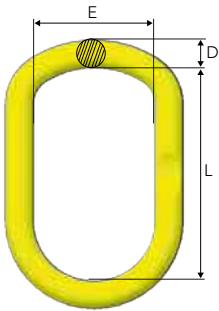

Art. no.	Code	WLL tonnes (SF 5:1)		For chain size, mm			L	E	D	DIN 15401	DIN 15402	Weight kg
		EN 1677-4	A952/A952M AS 3775.2	1-leg	2-leg	3-4 leg						
Z101262	MFH-1310-10	7.5	8.0	13	10	8	230	125	22	≤ 12	≤ 16	2.1
Z101263	MFH-1613-10	10.0	13.6	16	13	10	250	135	28	≤ 12	≤ 16	3.7
Z101264	MFH-2016-10	17.0	20.6	20	16	13	280	135	32	≤ 16	≤ 20	5.3
Z101265	MFH-2220-10	28.0	30.9	22	20	16	320	175	40	≤ 25	≤ 32	9.7
Z101266	MFHW-2220-10	28.0	28.0	22	20	16	355	225	40	≤ 50	≤ 63	11.1

Fulfills requirements in: EN 1677:2008 (WLL +25%), ASTM A952/A952M-02, AS 3775:2014 and AS 3776:2015.

Master Link with Sublinks MT

Designed for use with chain or wire rope. For 3- and 4-leg slings

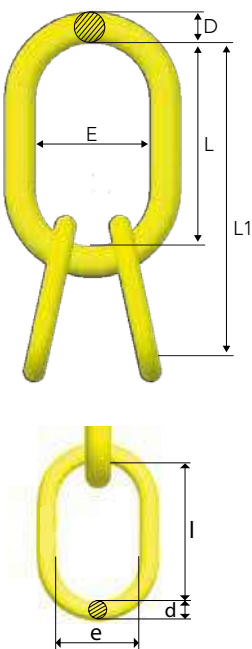

Art. no.	Code	WLL tonnes (SF 5:1)		L1	L	E	D	I	e	d	Weight kg
		EN 1677-4	A952/A952M AS 3775.2								
Z100902	MT-6-10	3.5	5.0	270	150	90	19	125	70	14	1.8
Z100903	MT-8-10	5.2	8.0	300	160	95	22	140	80	17	3.0
Z101359	MT-9-10	6.9	9.7	340	190	110	28	150	90	19	4.9
Z100904	MT-10-10	11.5	16.0	360	200	120	30	160	95	22	6.4
Z100905	MT-13-10	17.0	26.0	440	250	150	40	190	110	28	14.2
Z100906	MT-16-10	28.0	35.0	500	300	200	50	200	120	32	23
Z101074	MT-20-10	35.0	50.0	550	300	200	55	250	150	40	31.5
Z101281	MT-22-10	53.0	75.0	610	350	200	60	260	140	45	46
Z101282	MT-26-10	70.0	100.0	730	450	250	70	280	160	50	71
Z101283	MT-32-10	90.0	125.0	730	450	260	80	280	160	55	91

Fulfills requirements in: EN 1677:2008 (WLL +25%), ASTM A952/A952M-02, AS 3775:2014 and AS 3776:2015.

Flattened section on the sublinks for sizes up to MT-16-10 except MT-9-10.

Master Link MFX

Oversized, for 1- and 2-leg slings. Designed for use with CL, CLD, CG and CGD.

Art. no.	Code	WLL tonnes (SF 5:1)		For chain 1-leg	For chain 2-leg	L	E	D	Weight kg
		EN 1677-4	A952/A952M AS 3775.2						
Z100550	MFX-108-10	4.25	5.2	8, 10	8	340	180	25	3.7
Z100551	MFX-1310-10	7.5	8.0	13	10	340	180	28	4.7
Z100552	MFX-1613-10	11.2	13.6	16	13	340	180	34	7.1
Z101125	MFX-2016-10	16.0	20.6	20	16	340	180	40	9.6

Fulfills requirements in: EN 1677:2008 (WLL +25%), ASTM A952/A952M-02, AS 3775:2014 and AS 3776:2015.

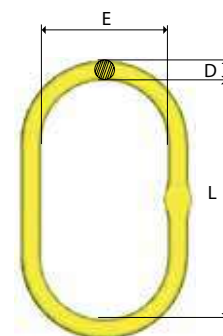

2

Master Grab MG

"All-in-one" compact top link.

Art. no.	Code	WLL tonnes*	L	A	E	D	Weight kg
B14710	MG-6-10	1.5	145	88	60	15	0.5
B14711	MG-8-10	2.6	171	92	60	18	0.9
B14712	MG-10-10	4.0	211	113	75	22	1.8
B14713	MG-13-10	6.8	261	138	90	26	3.5
B14714	MG-16-10	10.3	311	157	105	31	6.1

Fulfills requirements in: EN 1677:2008 (WLL +25%), ASTM A952/A952M-02 and AS 3776:2015.

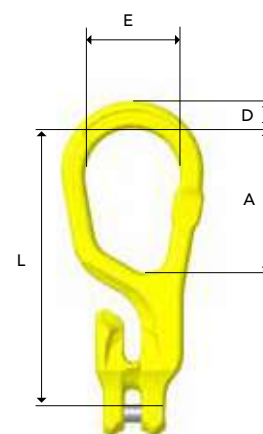

Master Grab Duo MGD

"All-in-one" compact top link for 2-leg slings.

Art. no.	Code	WLL tonnes*	L	A	E	D	Weight kg
B14700	MGD-6-10	2.1	144	90	60	17	0.7
B14701	MGD-8-10	3.5	171	100	75	21	1.3
B14702	MGD-10-10	5.6	211	124	90	24	2.3
B14703	MGD-13-10	9.5	262	149	105	31	5.2
B14704	MGD-16-10	14.0	310	175	120	35	7.9

Fulfills requirements in: EN 1677:2008 (WLL +25%), ASTM A952/A952M-02 and AS 3776:2015.

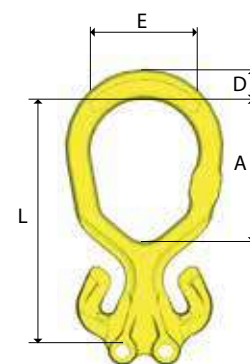

Coupling Link G

For use with master link and eye hook.

Art. no.	Code	WLL tonnes*	L	B	F	A	C	Weight kg
Z100821	G-6-10	1.5	45	15	7	8	16	0.1
Z101358	G-7-10	2.0	56	18	9	11	22	0.2
Z100822	G-8-10	2.6	56	18	9	11	22	0.2
Z100823	G-10-10	4.0	68	25	12	13	26	0.3
Z100824	G-13-10	6.8	89	29	15	17	33	0.7
Z100825	G-16-10	10.3	106	36	19	20	40	1.4
Z101119	G-20-10	16.0	125	43	23	26	44	2.2
Z101339	G-22-10	20.0	152	50	26	28	59	3.6
Z101365	G-26-10	27.3	161	58	32	34	61	5.7
Z101666	G-32-10	40.0	200	70	38	40	77	9.5

Fulfills requirements in: EN 1677:2008 (WLL +25%), ASTM A952/A952M-02 and AS 3776:2015.

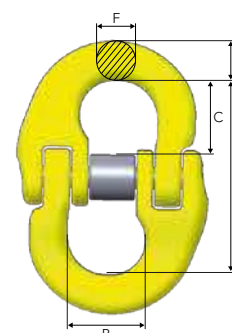

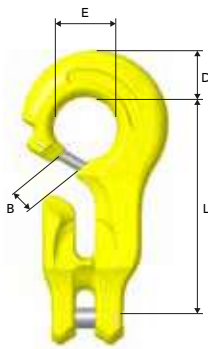

C-Grab CG

For use with master link, eye hooks and choke.

Art. no.	Code	WLL tonnes*	L	B	E	D	Weight kg
B14730	CG-6-10	1.5	80	11	24	19	0.3
B14731	CG-8-10	2.6	107	12	32	24	0.7
B14732	CG-10-10	4.0	134	15	40	29	1.5
B14733	CG-13-10	6.8	172	18	52	38	3.2
B14734	CG-16-10	10.3	215	22	64	47	6.1

Fulfills requirements in: EN 1677:2008 (WLL +25%), ASTM A952/A952M-02 and AS 3776:2015.

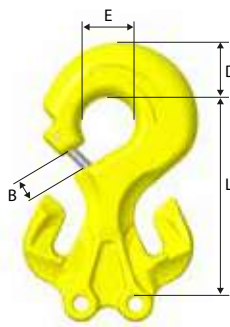

C-Grab Duo CGD

For use with master links.

Art. no.	Code	WLL tonnes*	L	B	E	D	Weight kg
B14720	CGD-6-10	2.1	79	11	24	20	0.6
B14721	CGD-8-10	3.5	107	12	32	29	1.1
B14722	CGD-10-10	5.6	134	15	40	37	2.2
B14723	CGD-13-10	9.5	173	19	48	48	5.4
B14724	CGD-16-10	14.0	215	22	64	57	9.1

Fulfills requirements in: EN 1677:2008 (WLL +25%), ASTM A952/A952M-02 and AS 3776:2015.

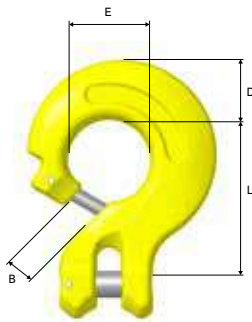

C-Lok CL

For use with master links, eye hooks and choke.

Art. no.	Code	WLL tonnes*	L	B	E	D	Weight kg
B14750	CL-6-10	1.5	43	11	24	18	0.2
B14751	CL-8-10	2.6	58	12	32	24	0.5
B14752	CL-10-10	4.0	74	15	40	29	1.0
B14753	CL-13-10	6.8	94	18	52	38	2.0
B14754	CL-16-10	10.3	119	22	64	48	3.8

Fulfills requirements in: EN 1677:2008 (WLL +25%), ASTM A952/A952M-02 and AS 3776:2015.

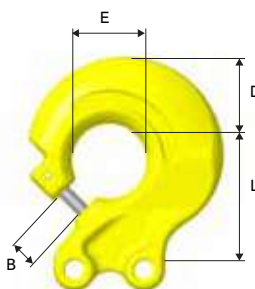

C-Lok Duo CLD

For use with master links.

Art. no.	Code	WLL tonnes*	L	B	E	D	Weight kg
B14740	CLD-6-10	2.1	43	11	24	22	0.4
B14741	CLD-8-10	3.5	58	12	32	29	0.6
B14742	CLD-10-10	5.6	74	15	40	37	1.2
B14743	CLD-13-10	9.5	94	18	52	46	3.1
B14744	CLD-16-10	14.0	119	25	64	57	5.5

Fulfills requirements in: EN 1677:2008 (WLL +25%), ASTM A952/A952M-02 and AS 3776:2015.

GrabiQ Chain KLA, Grade 10 (200)

Short link lifting chain

Heat treatment

Hardened and tempered.

Note! For chain grade 10 (200) the maximum in service temperature is 200°C.

Surface treatment

Painted blue

Fulfills the requirements in:

ASTM A973/A973M-07(2012)
EN 818+2:2008 (WLL+25%,
reduced temperature range)

Art. no. Box	Code	WLL tonnes	d nom.	P	w1	Weight kg/m	MPF kN	Breaking force kN
Z802300 - 1 x 200 m	KLA 6-10 (200)	1.5	6	18	8.5	0.8	36.8	58.9
Z802337 - 1 x 200 m	KLA 7-10 (200)	1.95	7	21	10.0	1.1	48	77
Z802301 - 1 x 200 m	KLA 8-10 (200)	2.6	8	24	11.0	1.4	63	102
Z802302 - 1 x 100 m	KLA 10-10 (200)	4.0	10	30	14.0	2.3	98	158
Z802303 - 1 x 100 m	KLA 13-10 (200)	6.8	13	39	17.7	3.8	166	268
Z802304 - 1 x 100 m	KLA 16-10 (200)	10.3	16	48	21.9	5.6	251	402
Z802305 - 1 x 50 m	KLA 20-10 (200)	16.0	20	60	27.0	9.4	393	630
Z802246 - 1 x 50 m	KLA 22-10 (200)	20.0	22	66	29.0	11.9	491	785
Z802248 - 1 x 50 m	KLA 26-10 (200)	27.0	26	78	35.0	16.4	664	1062
Z802440 - 1 x 25 m	KLA 32-10 (200)	40.0	32	96	41.6	25.8	981	1610

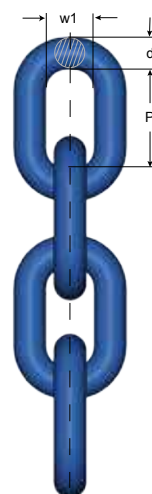

2

GrabiQ Chain KLA, Grade 10 (400)

Short link lifting chain

Heat treatment

Hardened and tempered.

Note! For chain grade 10 (400) the maximum in service temperature is 400°C.

Surface treatment

Painted blue

Fulfills the requirements in:

EN 818-2:2008 (WLL+25%,
material dimension \varnothing +10%)

Note: This chain is marked with "8+" in addition to the marking required by the machine directive

Art. no. Box	Code	WLL tonnes	d nom.	P	w1	Weight kg/m	MPF kN	Breaking force kN
Z802306 - 1 x 200 m	KLA 6-10 (400)	1.5	6.6	18	8.9	1.0	36.8	58.9
Z802307 - 1 x 200 m	KLA 8-10 (400)	2.5	8.8	24	11.2	1.7	63	102
Z802308 - 1 x 100 m	KLA 10-10 (400)	4.0	11.0	30	14.4	2.6	98	158
Z802309 - 1 x 100 m	KLA 13-10 (400)	6.7	14.3	39	19.2	4.5	166	268
Z802310 - 1 x 100 m	KLA 16-10 (400)	10.0	17.3	48	23.0	6.7	251	402

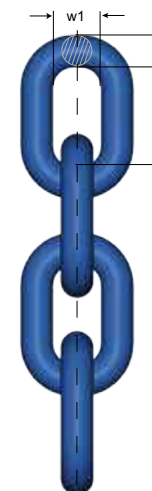

For larger sizes, see GrabiQ Grade 10 (200) or Classic Grade 8.

Marking and traceability of Gunnebo Industries chain

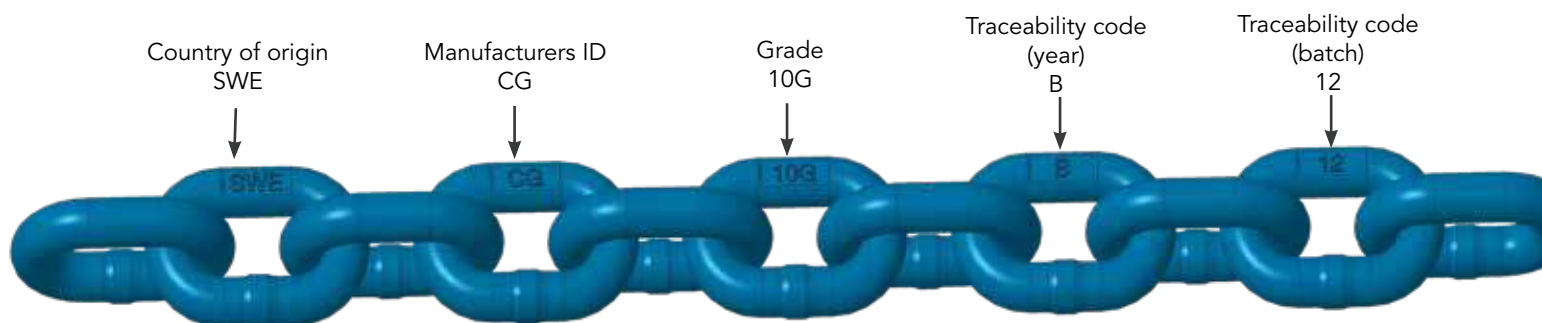

Grab Hook GG

Clevis shortening hook. No reduction of working load limit, thanks to supporting cradle lugs on either side of hook to prevent chain link deformation.

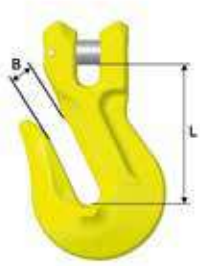

Art. no.	Code	WLL tonnes*	L	B	Weight kg
Z101844	GG-6-10	1.5	54	8	0.2
Z100845	GG-7-10	2.0	57	10	0.3
B14771	GG-8-10	2.6	57	10	0.4
B14772	GG-10-10	4.0	76	12	0.9
B14773	GG-13-10	6.8	97	16	1.8
B14774	GG-16-10	10.3	114	20	3.1
Z101152	GG-20-10	16.0	147	26	7.0

Fulfills requirements in: EN 1677:2008 (WLL +25%), ASTM A952/A952M-02 and AS 3776:2015.

Grab Hook GG with Locking Pin

Clevis shortening hook with locking pin for extra safety. No reduction of working load limit, thanks to supporting cradle lugs on either side of hook to prevent chain link deformation.

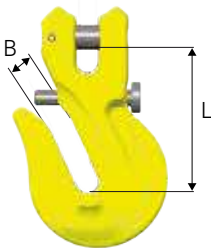

Art. no.	Code	WLL tonnes*	L	B	Weight kg
B14971	GG-8-10 LP	2.6	57	10	0.4
B14972	GG-10-10 LP	4.0	77	12	0.9
B14973	GG-13-10 LP	6.8	97	16	1.9
B14974	GG-16-10 LP	10.3	114	20	3.2

Fulfills requirements in: EN 1677:2008 (WLL +25%), ASTM A952/A952M-02 and AS 3776:2015.

Grab Hook OG

Eye shortening hook. No reduction of working load limit, thanks to supporting lugs on either side of hook to prevent chain link deformation.

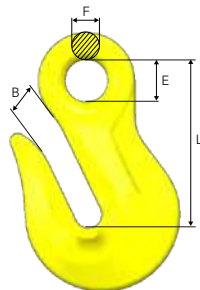

Art. no.	Code	WLL tonnes*	L	B	E	F	Weight kg
Z101296	OG-7/8-10	2.6	65	10	17	10	0.3
Z101297	OG-10-10	4.0	85	12	20	12	0.7
Z101298	OG-13-10	6.8	104	16	26	16	1.6
Z101299	OG-16-10	10.3	131	20	32	19	2.8
Z101300	OG-20-10	16.0	167	26	41	23	6.1
Z101301	OG-22-10	20.0	187	26	46	26	7.75
Z101302	OG-26-10	27.3	228	32	55	38	14
Z101303	OG-32-10	40.0	229	40	50	27	20.7

Fulfills requirements in: EN 1677:2008 (WLL +25%), ASTM A952/A952M-02 and AS 3776:2015.

Safety Hook GBK

Safety hook with clevis connector and grab latch.

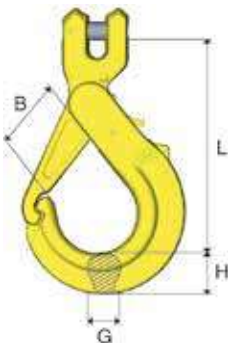

Art. no.	Code	WLL tonnes*	L	B	G	H	Weight kg
Z100758	GBK-6-10	1.5	87	26	15	17	0.4
Z100849	GBK-7-10	2.0	114	36	20	22	0.5
Z100759	GBK-8-10	2.6	119	36	20	22	0.8
Z100760	GBK-10-10	4.0	150	47	22	29	1.4
Z100761	GBK-13-10	6.8	172	53	29	38	2.7
Z100762	GBK-16-10	10.3	208	68	30	45	4.4

Fulfills requirements in: EN 1677:2008 (WLL +25%), ASTM A952/A952M-02 and AS 3776:2015.

Safety Hook BKG

Safety hook with clevis connector and standard latch.

Art. no.	Code	WLL tonnes*	L	B	G	H	Weight kg
Z101110	BKG-6-10	1.5	91	29	15	21	0.5
Z101098	BKG-7-10	2.0	120	37	17	22	0.5
Z101100	BKG-8-10	2.6	121	37	17	26	0.9
Z101026	BKG-10-10	4.0	144	45	21	31	1.5
Z101034	BKG-13-10	6.8	180	55	30	40	3.0
Z101042	BKG-16-10	10.3	219	62	37	50	5.5
Z101091	BKG-20-10	16.0	240	68	46	64	9.6

Fulfills requirements in: EN 1677:2008 (WLL +25%), ASTM A952/A952M-02 and AS 3776:2015.

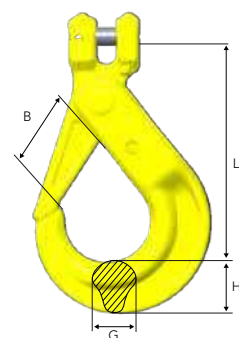

2

Safety Hook BKGC

Safety hook with clevis connector for skip loaders.

Art. no.	Code	WLL tonnes*	L	B	G	H	Weight kg
Z1002401	BKGC-13-10	6.8	164	55	27	43	3.2

Fulfills requirements in: EN 1677:2008 (WLL +25%), ASTM A952/A952M-02 and AS 3776:2015.

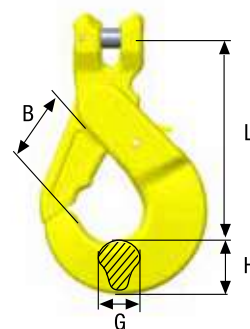

Sling Hook GKC

Sling hook with clevis connector for skip loaders.

Art. no.	Code	WLL tonnes*	L	B	G	H	Weight kg
Z7006461	GKC-13-10	6.8	188	60	27	43	2.5

Fulfills requirements in: EN 1677:2008 (WLL +25%), ASTM A952/A952M-02 and AS 3776:2015.

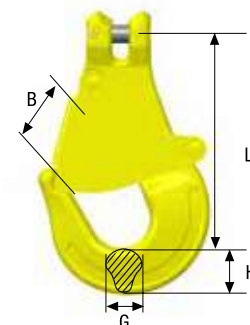

Safety Hook OBK

Safety hook with eye connector and grip latch.

Art. no.	Code	WLL tonnes*	A	L	B	E	F	G	H	Weight kg
Z101048	OBK-6-10	1.5	12	103	26	22	9	15	17	0.4
Z101143	OBK-7/8-10	2.6	14	139	37	28	10	20	22	0.8
Z101145	OBK-10-10	4.0	16	170	47	34	13	22	29	1.3
Z101147	OBK-13-10	6.8	21	206	53	44	15	29	38	2.6
Z101141	OBK-16-10	10.3	26	251	68	56	19	29	45	4.4
Z101240	OBK-18/20-10	16.0	28	293	74	60	22	44	56	8.3

Fulfills requirements in: EN 1677:2008 (WLL +25%), ASTM A952/A952M-02 and AS 3776:2015.

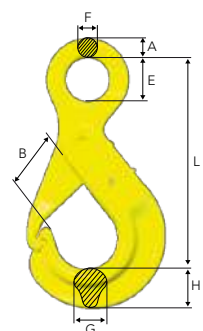

BK Safety Hook

The Original

Gunnebo Industries continuously works with product development and innovation to create the optimal solutions for each lifting situation. Since the early 1950's we have developed products that have become today's standards on the market. There is however only one original - Gunnebo Industries. With the original you get the perfect fit and smart details.

Back in 1965 Gunnebo Industries developed the BK hook. The mission was to increase the workplace safety of the construction industry. Today this popular and well known hook is the foundation of the innovative and much appreciated BK product family.



Clear markings

- Country of origin.
- Traceability codes.
- Model, size and grade.

Increased flexibility

- The eye design enables connection to not only G-links, but also C-links and Berglok.
- The design makes the BK hook suitable for steel wire ropes.

Flat section

- For attachment to other GrabiQ or wire components.

Heavy duty rivet

- Recessed rivet for a slim design.
- Decreases the risk of snagging.
- Ideal in narrow spaces.

Latch rotation stop

- Protects the trigger mechanism from damage.

Quality is top priority

- Fatigue tested.
- Forged alloy steel.
- Hardened and tempered.
- Every hook is individually proof-loaded at 2,5 x WLL.
- Full traceability back to the raw material.

Precision manufacturing

- Perfect fit between the parts.
- Increases safety during operation.

Replaceable trigger set

- Quick and easy assembly.
- Available as a complete spare part kit.

Recessed trigger

- To avoid the trigger from snagging or being damaged, it has been recessed into the body of the hook.
- Helps to prevent the latch from accidentally opening.

Fluorescent color

- For high visibility in the field.



Safety Hook BK

The "original" safety hook with eye connector.

Art. no.	Code	WLL tonnes*	A	L	B	E	F	G	H	Weight kg
Z101108	BK-6-10	1.5	12	109	29	22	10	15	21	0.5
Z101097	BK-7/8-10	2.6	14	138	37	28	11	17	26	0.9
Z101024	BK-10-10	4.0	16	168	45	34	13	21	31	1.5
Z101032	BK-13-10	6.8	20	207	55	44	16	30	40	3.0
Z101040	BK-16-10	10.3	26	254	62	56	20	37	50	5.5
Z101089	BK-18/20-10	16.0	30	289	68	60	22	44	64	9.0
Z101325	BK-22-10	20.0	32	320	80	70	24	50	64	11.3
Z101326	BK-26-10	27.3	35	342	100	80	25	54	68	16.5

Fulfills requirements in: EN 1677:2008 (WLL +25%), ASTM A952/A952M-02 and AS 3776:2015.

For larger sizes, see Classic Grade 8.

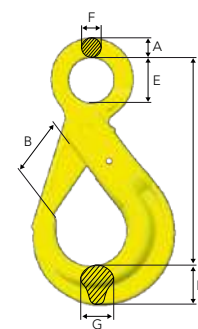

2

Safety Hook BKD

Double latch BK-hook with recessed trigger. Should the first hook latch accidentally open, either through direct impact or excessive wear on the trigger, the extra latch is there to retain the load safely. The secondary latch is designed to be easily operated and will not cause inconvenience for the operator.

Art. no.	Code	WLL tonnes*	A	L	B	E	F	G	H	Weight kg
Z101154	BKD-13-10	6.8	20	207	44	44	16	30	40	3.2
Z101155	BKD-16-10	10.3	26	254	48	56	20	37	50	5.8
Z101156	BKD-18/20-10	16.0	30	289	52	60	22	46	62	9.1

Fulfills requirements in: EN 1677:2008 (WLL +25%), ASTM A952/A952M-02 and AS 3776:2015.

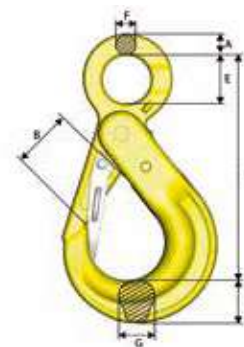

Double latch

Should the hook latch accidentally open, either through direct impact or excessive wear on the trigger, the extra latch is there to retain the load safely. The extra latch is designed to be easily operated.

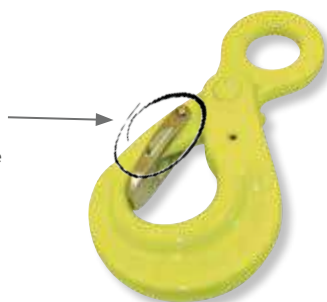

Shank Safety Hook BKT

Safety hook with shank for customized machines.

Art. no.	Code	WLL tonnes*	L	B	L1	D	dmin	G	H	Weight kg
Z1011120	BKT-6-10	1.5	90	29	36	20	11	15	21	0.5
Z1011020	BKT-7/8-10	2.6	111	37	47	24	13	17	26	0.9
Z1010690	BKT-10-10	4.0	133	45	51	29	16	21	31	1.6
Z1010710	BKT-13-10	6.8	160	55	77	34	20	30	39	3.0

Fulfills requirements in: EN 1677:2008 (WLL +25%), ASTM A952/A952M-02 and AS 3776:2015.

d min = the smallest permitted shank dimension after machining.

Note! After machining of the shank, proof loading must be carried out.

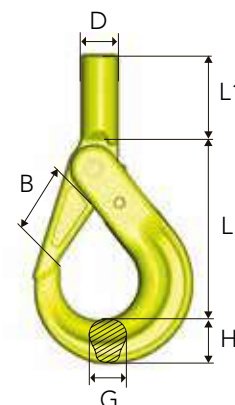

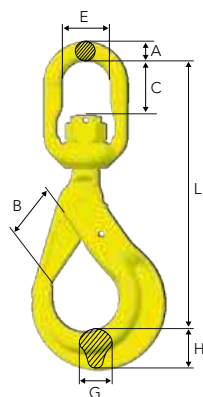

Swivel Safety Hook BKL

Safety hook with swivel for improved positioning of the hook before the load is lifted (360° rotation).

Art. no.	Code	WLL tonnes*	L	B	C	E	A	G	H	Weight kg
Z101114	BKL-6-10	1.5	149	29	23	33	11	15	21	0.7
Z101104	BKL-7/8-10	2.6	183	37	27	38	12	17	26	1.2
Z101028	BKL-10-10	4.0	218	45	37	44	15	21	31	2.0
Z101036	BKL-13-10	6.8	282	55	49	48	19	30	40	4.0
Z101044	BKL-16-10	10.3	341	62	65	61	25	37	50	7.2
Z101093	BKL-18/20-10	16.0	368	68	70	72	31	44	62	11.4

Fulfills requirements in: EN 1677:2008 (WLL +25%), ASTM A952/A952M-02 and AS 3776:2015.

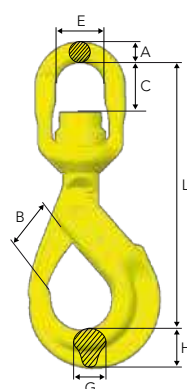

Swivel Safety Hook BKLK

Safety hook with ball-bearing for 360° rotation under full WLL.

Art. no.	Code	WLL tonnes*	L	B	C	E	A	G	H	Weight kg
Z101116	BKLN-6-10	1.5	149	29	24	33	11	15	21	0.7
Z101106	BKLN-7/8-10	2.6	183	37	27	38	12	17	26	1.2
Z101030	BKLN-10-10	4.0	218	45	35	44	15	21	31	2.0
Z101038	BKLN-13-10	6.8	280	55	45	48	19	30	40	4.0
Z101046	BKLN-16-10	10.3	339	62	62	61	25	37	50	7.3
Z101095	BKLN-18/20-10	16.0	368	68	60	72	31	44	62	11.5
Z101294	BKLN-22-10	20.0	436	79	80	80	35	50	62	16.8
Z101295	BKLN-26-10	27.3	486	100	110	102	45	54	68	26.0

Fulfills requirements in: EN 1677:2008 (WLL +25%), ASTM A952/A952M-02 and AS 3776:2015.

For larger sizes, see Classic Grade 8.

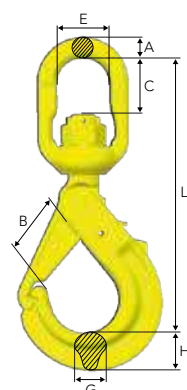

Swivel Safety Hook with Griplatch LBK

Safety hook with griplatch and swivel for improved positioning of the hook before the load is lifted (360° rotation).

Art. no.	Code	WLL tonnes*	L	B	C	E	A	G	H	Weight kg
Z100978	LBK-7/8-10	2.6	177	37	27	38	12	20	22	1.1
Z100960	LBK-10-10	4.0	214	47	37	44	15	22	29	1.8
Z100993	LBK-13-10	6.8	262	53	45	48	19	29	38	3.5
Z100995	LBK-16-10	10.3	324	68	66	61	25	30	45	5.9

Fulfills requirements in: EN 1677:2008 (WLL +25%), ASTM A952/A952M-02 and AS 3776:2015.

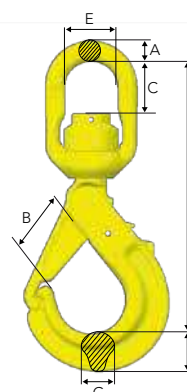

Swivel Safety Hook with Griplatch LKBK

Safety hook with griplatch and ball-bearing for 360° rotation under full WLL.

Art. no.	Code	WLL tonnes*	L	B	C	E	A	G	H	Weight kg
Z100980	LKBK-7/8-10	2.6	176	37	27	38	12	20	22	1.1
Z100962	LKBK-10-10	4.0	213	47	35	44	15	22	29	1.9
Z100997	LKBK-13-10	6.8	261	53	43	48	19	29	38	3.6
Z100999	LKBK-16-10	10.3	323	68	61	61	25	30	45	6.2

Fulfills requirements in: EN 1677:2008 (WLL +25%), ASTM A952/A952M-02 and AS 3776:2015.

Sling Hook EGK

Sling hook with clevis connector.

Art. no.	Code	WLL tonnes*	L	B	G	H	Weight kg
Z100915	EGK-6-10	1.5	86	29	17	20	0.4
Z100918	EGK-7-10	2.0	95	32	17	22	0.5
Z100938	EGK-8-10	2.6	95	32	17	23	0.5
Z100942	EGK-10-10	4.0	121	41	23	31	1.0
Z100946	EGK-13-10	6.8	145	49	28	38	2.0
Z100950	EGK-16-10	10.3	170	61	36	46	3.8
Z101138	EGK-20-10	16.0	209	71	42	60	7.3

Fulfills requirements in: EN 1677:2008 (WLL +25%), ASTM A952/A952M-02 and AS 3776:2015.

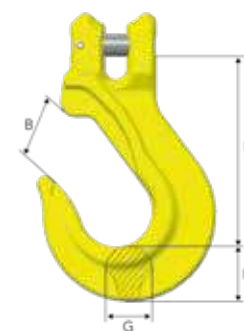

2

Sling Hook EGKN

Sling hook with latch.

Art. no.	Code	WLL tonnes*	L	B	G	H	Weight kg
B14460	EGKN-6-10	1.5	86	25	17	20	0.4
Z100843	EGKN-7-10	2.0	95	27	17	23	0.5
B14461	EGKN-8-10	2.6	95	28	17	23	0.5
B14462	EGKN-10-10	4.0	121	35	23	31	1.1
B14463	EGKN-13-10	6.8	145	42	28	38	2.2
B14464	EGKN-16-10	10.3	170	53	36	46	4.0
Z101127	EGKN-20-10	16.0	209	65	42	60	7.6

Fulfills requirements in: EN 1677:2008 (WLL +25%), ASTM A952/A952M-02 and AS 3776:2015.

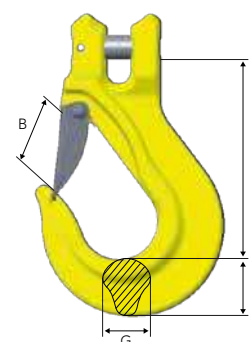

Sling Hook EK

Sling hook with eye connector.

Art. no.	Code	WLL tonnes*	L	B	E	F	G	H	Weight kg
Z101162	EK- 6-10	1.5	93	29	23	10	17	20	0.4
Z101164	EK- 7/8-10	2.6	108	32	28	12	17	23	0.5
Z101166	EK-10-10	4.0	134	41	34	14	23	30	0.9
Z101168	EK-13-10	6.8	166	49	44	18	28	38	2.0
Z101170	EK-16-10	10.3	203	61	56	22	36	47	3.3
Z101306	EK-20-10	16.0	229	71	61	26	42	60	6.2
Z101307	EK-22-10	20.0	267	82	64	31	43	67	8.5
Z101308	EK-26-10	27.3	301	95	66	32	51	75	12.1
Z101309	EK-32-10	40.0	353	105	90	38	61	98	24.6

Fulfills requirements in: EN 1677:2008 (WLL +25%), ASTM A952/A952M-02 and AS 3776:2015.

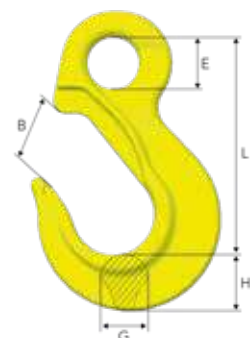

Sling Hook EKN

Sling hook with latch.

Art. no.	Code	WLL tonnes*	L	B	E	F	G	H	Weight kg
Z101128	EKN- 6-10	1.5	93	25	23	10	17	20	0.4
Z101130	EKN- 7/8-10	2.6	108	26	28	12	17	23	0.6
Z101132	EKN-10-10	4.0	134	37	34	14	23	30	1.0
Z101134	EKN-13-10	6.8	166	42	44	18	28	38	2.1
Z101136	EKN-16-10	10.3	203	53	56	22	36	47	4.0
Z101327	EKN-20-10	16.0	229	60	61	26	42	60	6.4
Z101328	EKN-22-10	20.0	267	73	64	31	43	67	8.9
Z101329	EKN-26-10	27.3	301	82	66	32	51	75	13.0
Z101330	EKN-32-10	40.0	353	96	90	38	61	98	25.0

Fulfills requirements in: EN 1677:2008 (WLL +25%), ASTM A952/A952M-02 and AS 3776:2015.

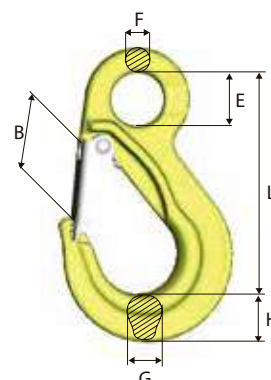

Foundry Hook OKE

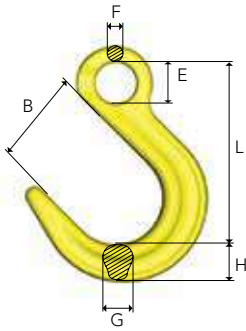

Art. no.	Code	WLL tonnes*	L	B	E	F	G	H	Weight kg
Z100853	OKE-7/8-10	2.6	124	63	28	12	21	26	0.8
Z100854	OKE-10-10	4.0	151	76	34	15	26	30	1.4
Z100855	OKE-13-10	6.8	184	90	44	19	33	39	2.8
Z100898	OKE-16-10	10.3	218	102	56	23	40	46	4.9
Z101340	OKE-20-10	16.0	247	114	60	27	46	60	7.2
Z101341	OKE-22-10	20.0	275	120	64	31	60	70	11.3
Z101342	OKE-26-10	27.3	300	113	70	35	64	77	16.0

Fulfills requirements in: EN 1677:2008 (WLL +25%), ASTM A952/A952M-02 and AS 3776:2015.

For larger sizes, see Classic Grade 8.

Swivel Latch Hook LKN

Sling hook with swivel for improved positioning of the hook before the load is lifted (360° rotation).

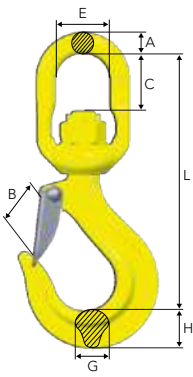

Art. no.	Code	WLL tonnes*	For chain dim.	L	B	C	E	A	G	H	Weight kg
Z101345	LKN-7/8-10	2.6	7, 8	155	28	28	38	12	18	24	0.8
Z101346	LKN-10-10	4.0	10	192	35	37	44	15	23	31	1.5
Z101347	LKN-13-10	6.8	13	238	40	47	48	19	28	38	3.1
Z101348	LKN-16-10	10.3	16	295	53	65	61	25	34	43	5.3

Fulfills requirements in: EN 1677:2008 (WLL +25%), ASTM A952/A952M-02 and AS 3776:2015.

Swivel Latch Hook LKNK

Swivel latch hook with ball bearing for 360° rotation under full WLL.

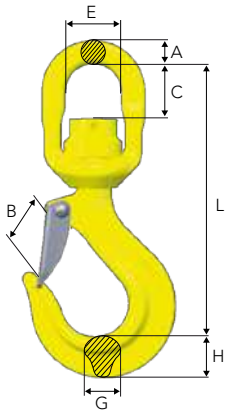

Art. no.	Code	WLL tonnes*	For chain dim.	L	B	C	E	A	G	H	Weight kg
Z101349	LKNK-7/8-10	2.6	7, 8	154	28	28	38	12	18	24	0.9
Z101350	LKNK-10-10	4.0	10	191	35	35	44	15	23	31	1.6
Z101351	LKNK-13-10	6.8	13	236	40	45	48	19	28	38	3.3
Z101352	LKNK-16-10	10.3	16	293	53	62	61	25	34	43	5.6
Z101354	LKNK-22-10	20.0	22	400	74	80	80	35	43	67	15.1

Fulfills requirements in: EN 1677:2008 (WLL +25%), ASTM A952/A952M-02 and AS 3776:2015.

Clevis Swivel Hook LKNG

For direct connection to cranes or similar applications.

Sling hook with swivel for improved positioning of the hook before the load is lifted (360° rotation).

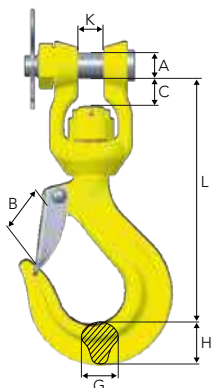

Art. no.	Code	WLL tonnes*	For chain dim.	L	B	C	A	G	H	K	Weight kg
Z101353	LKNG-16-10	10.3	16	258	53	30	28	34	43	27	5.7

Fulfills requirements in: EN 1677:2008 (WLL +25%), ASTM A952/A952M-02 and AS 3776:2015.

Roundsling Hook RH

The RH-hook is the perfect load connection solution, combining the advantages of both soft lifting slings and grade 100 components. It can be inserted into a softsling and is quicker and safer to use than the commonly used shackle. The RH-hook is a connector as well as a hook, which gives the user increased flexibility, safer use and increased durability of the soft slings.

The RH-hook comes with a blocking pin, but thanks to the narrow opening it may be used without blocking pin.



Tested according to EN 1677-2

Art. no.	Code	WLL tonnes*	B	E	G	L	H	M	Weight kg
B14490	RH-1-10	1	24	35	16.6	84	19	8	0.5
B14491	RH-2-10	2	28	40	17	96	22	10	0.7
B14492	RH-3-10	3	33	47	24	117	30	12	1.3
B14493	RH-5-10	5	43	73	27	155	36	16.5	3.2



The roundsling hooks are color coded in order to match the corresponding sizes of roundslings marked according to EN 1492: Red=5T, Yellow=3T, Green=2T and Violet=1T.

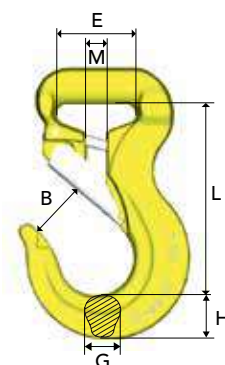

2

Container Hook CH

Made for lifting containers in their lower fittings.

Art. no.	Code	WLL tonnes*	A	L	E	B	H	G	Weight kg
Z101220	CH-3	12.5	25	187	70	46	47	75	3.8
Z101221	CH-3, 45° left	12.5	25	187	70	46	47	75	3.8
Z101219	CH-3, 45° right	12.5	25	187	70	46	47	75	3.8

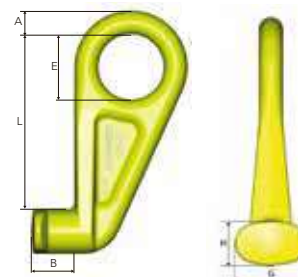

Alt. 1 - Straight lift

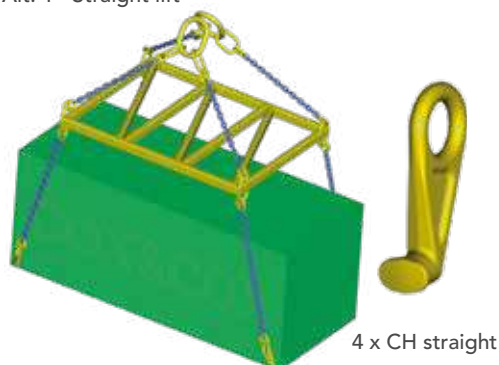

Alt. 2 - Angular lift

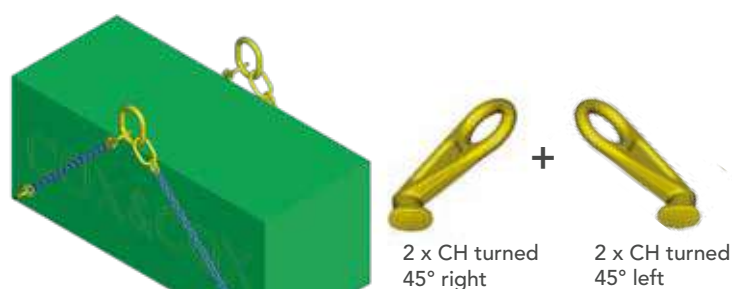

Chain Tensioner GT for lifting

Art. no	Model	WLL tonnes*	STF (daN)	L = Min. length (mm)	L = Max. length (mm)	Weight (kg)
Z101367	GT-8-10	2.6	2800	400	600	3.3
Z101368	GT-10-10	4.0	2800	400	600	3.3

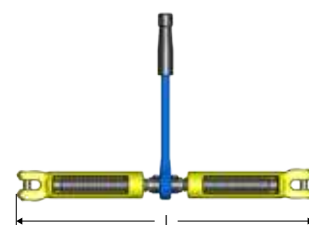

Offshore Components



GUNNEBO
Industries

Arctic Offshore

Innovation and quality with a purpose

We have developed products to meet the stringent requirements of the offshore oil & gas industry for many years. The working conditions are tough and products have to be able to sustain extreme conditions. Our double latch hook, BKD, was developed with the aerospace industry as a role model; if one system fails another one is ready to save the situation. The extra latch on the BKD will retain the load in case an unintended opening of the first latch should occur.

Our lifting systems have been valued for their long durability and quality. Regardless of the environmental conditions, our systems have provided lifting operations with high safety. Our quality systems give us the tools to work with continuous improvements and we will always put our great efforts into our mission to create the best available products in the market. Our quality is there with a purpose.

DNV 2.7-1 certificate

We are type-approved by DNV to manufacture master links and shackles in accordance with DNV 2.7.1 specification. The approval verifies that Gunnebo Industries has a high consistent level of production stability in the entire process, from raw material to the finished product.



-40°C



Arctic Offshore Master Links

Type approved to DNV 2.7-1

Adverse weather and rough sea conditions - sometimes in combination with extremely low temperatures - must be included in the design and safety factor of container lifting sets. The heat treatment of the components must ensure proper ductility and strength to better handle potential dynamic forces which may be imposed when the container is lifted from the deck of a vessel.

The lifting sets and its included components must be specially designed for the purpose to lift offshore containers. One of the main differences compared to the onshore standard or specification, is that it allows for the dynamic forces at sea by adding an extra enhancement factor to increase the level of safety. Another difference is that the requirements and testing of materials that will be used in cold environments, are more extensive.

Arctic Offshore Master Link M

DNV 2.7-1 and DNV 2.7-3 Type Approved.

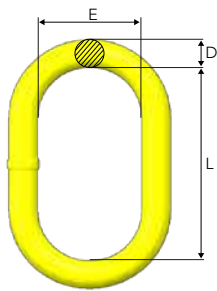

Art. no.	Code	Working Load Limits				L	E	D	Weight kg
		DNV 2.7-1		EN1677-4	A952/A952M				
		tonnes	Max. Container rating kg	SF 5:1 tonnes	SF 5:1 tonnes				
Z101486	M-9T- OS	9.3	4 500	9.3	9.3	275	145	25	3.1
Z101487	M-12T- OS	12.5	7 500	12.5	12.5	275	145	28	3.9
Z101488	M-18T- OS	18.5	13 500	18.5	18.5	275	145	32	5.2
Z101489	M-24T- OS	24.0	21 000	24.0	24.0	285	155	36	6.9
Z101490	M-30T- OS	30.5	25 000	30.5	30.5	270	140	40	8.1
Z101491	M-40T- OS	40.0	N/A	40.0	40.0	340	180	45	12.9
Z101492	M-50T- OS	50.0	N/A	50.0	50.0	300	200	50	15.2
Z101493	M-65T- OS	65.0	N/A	65.0	65.0	350	200	55	20.5
Z101494	M-90T- OS	90.0	N/A	90.0	90.0	450	250	70	42.4
Z101495	M-125T- OS	125.0	N/A	125.0	125.0	450	260	80	57.1

Arctic Offshore Master Link MT

DNV 2.7-1 and DNV 2.7-3 Type Approved.

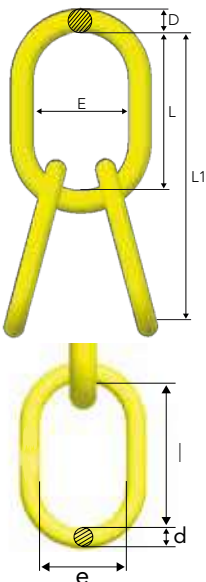

Art. no.	Code	Working Load Limits				L1	L	E	D	I	e	d	Weight kg
		DNV 2.7-1		EN 1677-4	A952/A952M								
		tonnes	Max. container rating kg	SF 5:1 tonnes	SF 5:1 tonnes								
Z101586	MT-9T- OS	9.3	4 500	9.3	9.3	435	275	145	25	160	95	22	6.1
Z101587	MT-12T- OS	12.5	7 500	12.5	12.5	435	275	145	28	160	95	25	7.8
Z101588	MT-18T- OS	18.5	13 500	18.5	18.5	465	275	145	32	190	110	28	10.9
Z101589	MT-24T- OS	24.0	21 000	24.0	24.0	560	285	155	36	275	145	32	17.3
Z101590	MT-30T- OS	30.5	25 000	30.5	30.5	555	270	140	40	285	155	36	21.9
Z101591	MT-40T- OS	40.0	N/A	40.0	40.0	610	340	180	45	270	140	40	29.2
Z101592	MT-50T- OS	50.0	N/A	50.0	50.0	640	300	200	50	340	180	45	41.1
Z101593	MT-65T- OS	65.0	N/A	65.0	65.0	650	350	200	55	300	200	50	50.9

All sublinks have a WLL of min. 75% of the top link.

Master link selection chart

Reference: DNV 2.7-1 June 2013, table 8.1

Container rating (kg)	Enhancement factor	Min. required WLL (t)	Recommended Master link M	Recommended Master link MT
500	-	7.00		
1000	-	7.00		
1500	-	7.00		
2000	3.500	7.00		
2500	2.880	7.20	M-9T OS	MT-9T OS
3000	2.600	7.80		
3500	2.403	8.41		
4000	2.207	8.83		
4500	2.067	9.30		
5000	1.960	9.80		
5500	1.873	10.30		
6000	1.766	10.60	M-12T OS	MT-12T OS
6500	1.733	11.26		
7000	1.700	11.90		
7500	1.666	12.50		
8000	1.633	13.07		
8500	1.600	13.60		
9000	1.567	14.10		
9500	1.534	14.57		
10000	1.501	15.01		
10500	1.479	15.53	M-18T OS	MT-18T OS
11000	1.457	16.02		
11500	1.435	16.50		
12000	1.413	16.95		
12500	1.391	17.38		
13000	1.368	17.79		
13500	1.346	18.18		
14000	1.324	18.54		
14500	1.302	18.88		
15000	1.280	19.20		
15500	1.267	19.64		
16000	1.254	20.06		
16500	1.240	20.47		
17000	1.227	20.86		
17500	1.214	21.24	M-24T OS	MT-24T OS
18000	1.201	21.61		
18500	1.188	21.97		
19000	1.174	22.31		
19500	1.161	22.64		
20000	1.148	22.96		
20500	1.143	23.44		
21000	1.139	23.92		
21500	1.135	24.39		
22000	1.130	24.86		
22500	1.126	25.33		
23000	1.121	25.79	M-30T OS	MT-30T OS
23500	1.117	26.25		
24000	1.112	26.70		
24500	1.108	27.15		
25000	1.104	27.59		

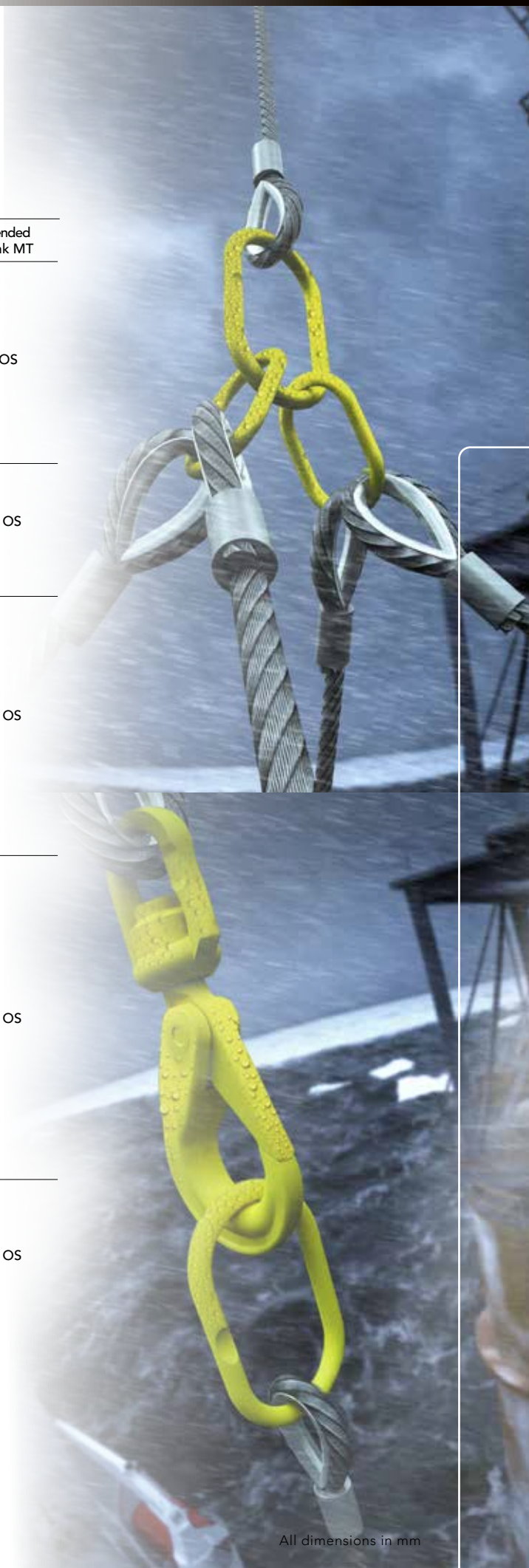

Offshore HDG Safety Hook

- Longer lifetime and less maintenance in corrosive environments
- Type approved to DNVGL-ST-0378 and DNVGL-ST-0377

Offshore HDG Safety hook is a unique DNV type approved offshore safety hook with dual surface treatment. The dual surface treatment optimizes corrosion protection through Hot Dip Galvanization (HDG), and gives high visibility in the field with its fluorescent powder coating.

It has all the benefits that our original BK Safety hook has, but is designed to meet the specific challenges in offshore environments by being manufactured to exacting demands and with preventive actions taken to avoid hydrogen embrittlement.

Swivel Safety Hook BCLK Offshore HDG

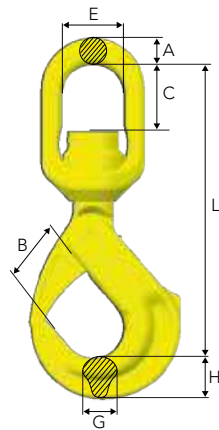

Art. no.	Code	WLL	WLL	L	B	C	E	A	G	H	Weight kg
		tonnes 4:1	tonnes 5:1								
ZG101370	BCLK-13-8 OS W HDG	6.7	5.4	307	55	72	61	25	30	40	4.9
ZG101371	BCLK-16-8 OS W HDG	10.3	8.2	365	62	88	82	26	37	50	8.4
ZG1013561	BCLK-18/20-8 OS W HDG	16.0	12.8	395	68	88	80	35	46	64	13.9
ZG101294	BCLK-22-8 OS HDG	20.0	16.0	436	79	80	80	35	50	62	16.8
ZG101295	BCLK-26-8 OS HDG	27.3	21.6	486	100	110	102	45	54	68	26.5
ZG101344	BCLK-32-8 OS HDG	32.8	26.2	533	120	110	102	45	62	86	32.3
With double latch											
ZGS1167	BCLKD-13-8 OS W HDG	6.7	5.4	307	55	72	61	25	30	40	5.0
ZGS1168	BCLKD-16-8 OS W HDG	10.3	8.2	365	62	88	82	26	37	50	8.8
ZGS1169	BCLKD-18/20-8 OS W HDG	16.0	12.8	395	68	88	80	35	46	64	14.3

Fulfills requirements in: DNVGL-ST-0377:2016, DNVGL-ST-0378:2016, NORSOK R-002:2017, EN 1677:2008 (WLL+25%), ASTM A952/A952M-02, AS3776:2015 and AS 3775:2014.

Double latch

Due to the motion of the sea when loading and unloading offshore, direct impact on the hook could cause the latch to unintentionally open when not being under load, risking the load to unhitch. The double latch safety hook has an extra latch retaining the load in this case.

Safety Hook BK Offshore HDG

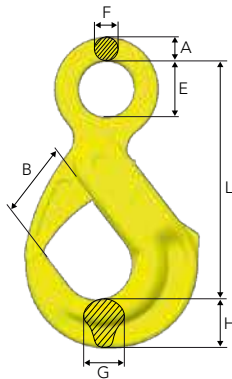

Art. no.	Code	WLL	WLL	L	B	E	F	G	H	Weight kg
		tonnes 4:1	tonnes 5:1							
ZG101355	BK-26-8 OS HDG	27.3	21.6	342	100	80	25	54	68	16.5
ZG101364	BK-32-8 OS HDG	32.8	26.2	400	120	90	30	62	86	23.3

Fulfills requirements in: DNVGL-ST-0377:2016, DNVGL-ST-0378:2016, NORSOK R-002:2017, EN 1677:2008 (WLL+25%), ASTM A952/A952M-02, AS3776:2015 and AS 3775:2014.

See our Offshore Shackles in chapter 4





Increased safety in heavy lifting operations

The WRIN STR Handle is a safety handle that provides additional safety to the Gunnebo Industries' BK safety hook family. With the WRIN STR Handle the operator opens and closes the safety hook without placing any hands inside the hook, resulting in a reduced risk of personal injury on worksites. The handle is easily mounted to the safety hook, without compromising the integrity of design and capabilities of the hook.

2

Improved workplace safety

- With the WRIN STR Handle there is no need to place a hand inside the safety hook, resulting in a reduced risk of personal injury on worksites.

Suitable to any safety hook within the BK family

- The WRIN STR Handle is easily mounted to any safety hook within the BK family.
- For sling shops the WRIN STR Handle is the perfect complement to the BK safety hooks, reducing the need for a large assortment of different safety hooks.
- If the handle is fully operable, it can be mounted and reused on a new hook if the existing hook is worn out.



Unique design

- The handle will keep the integrity of the hook's design and capabilities uncompromised.
- The handle is clamped to the hook and fixed by the hook's trigger pin.
- Hole for attaching a lead line for easy retrieval.
- Made of quality stainless steel according to AISI 316.

WRIN STR Handle

Suitable to any safety hook within the Gunnebo Industries BK family.

Art. no.	Code	Hook size (mm)	Dimensions (mm)				Suits the following safety hooks:	Weight (kg)
			L	H	B	G		
Z101413	STRG13	13	145	103	60	184	BK, BKD, BKG, BKL, BKLK, BKLD	0.75
Z101414	STRG16	16	182	140	80	255	BK, BKD, BKG, BKL, BKLK, BKLD	1.90
Z101415	STRG20	18/20	194	155	90	280	BK, BKD, BKG, BKL, BKLK, BKLD	2.50
Z101416	STRG22	22	203	164	90	300	BK, BKLK	2.60
Z101417	STRG26	26	215	192	103	348	BK, BKLK	3.45
Z101418	STRG32	32	263	179	103	380	BK, BKLK	3.90

Material: Stainless steel according to AISI 316.

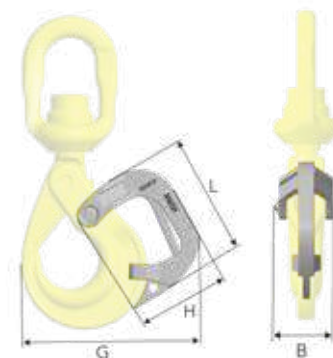

Classic Components



GUNNEBO
Industries

The SK-system with endless possibilities

A range of specialized components for safe and easy assembly to chain, steel wire rope, webbing and roundsling, designed to solve your below-the-hook problems.

The polyester sling system provides:

- Universal coupling of components to chain, wire and synthetic slings.
- Quick and simple assembly - only a hammer needed.
- Easy assembly - standardized dimensions within each size range effectively eliminates the incorrect assembly of components with different safe working loads.
- Heavy hoisting with strong yet lightweight equipment, all components are manufactured from alloy steel for use with Grade 8 chain.



2

SKA - pin & collar

The SKA set, containing pin and collar, can be used to connect all products in the SK-range. This creates a multitude of available combinations, each adaptable to the unique lifting situation.

The SKA-set gives you flexibility - it can be disassembled and put in new combinations, to provide solutions for a versatile lifting environment.



SKLI/SKLU

Electrically insulated, lubricated, sealed roller bearing swivel. Fully rotational even at maximum load. Tested to resist 1000 V. Suitable for protection of overhead cranes during welding operations on suspended loads.

By using the SKLI/SKLU with the SK-system you get a versatile solution that will fit almost any situation.

Roller-Bearing Swivel SKLI/SKLU

Electrically insulated, lubricated, sealed roller bearing swivel. Fully rotational even at maximum load. Tested to resist 1000 V. Suitable for protection of overhead cranes during welding operations on suspended loads.

The Gunnebo Industries SKLI is equipped with a heavy duty roller bearing, enabling high durability and safe use also under severe load. It also has heavy duty nylon insulation inside to decrease friction when in use. The SKLI is compatible with the entire Gunnebo Industries SK-range for versatile use.

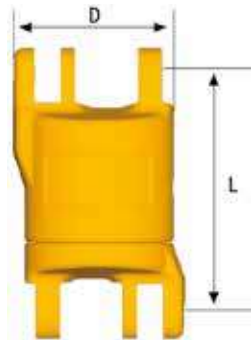

Roller-bearing Swivel SKLI/SKLU

Art. no.	Code	WLL tonnes*	For chain dim.	L	D	Weight kg
Z100316	SKLI-7/8-8	2.0	7, 8	75	48	0.7
Z100414	SKLI-10-8	3.2	10	97	59	1.3
Z100415	SKLI-13-8	5.4	13	120	75	2.8
Z100416	SKLI-16-8	8.0	16	137	90	4.6
Z100417	SKLI-18/20-8	12.8	19	159	104	7.3
RS16520	SKLU-22-8*	15.5	22	160	109	9.2
RS16530	SKLU-26-8*	21.7	26	207	135	18.3

Fulfills requirements in: EN 1677:2008, ISO 8539:2009, ASTM A952/A952M-02, AS 3776:2015 and SANS 1595:2003.

* Uninsulated

Load Pin and Locking Collar - SKA

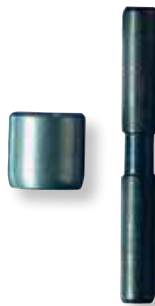

Art. no.	Code	Weight kg
Z700674	SKA-6-8	0.01
Z323624	SKA-7/8-8	0.02
Z318024	SKA-10-8	0.04
Z303822	SKA-13-8	0.08
Z303725	SKA-16-8	0.14
Z145048	SKA-18/20-8	0.26
Z133530	SKA-22-8	0.35
Z605407	SKA-26-8	0.63
Z650554	SKA-32-8	1.05

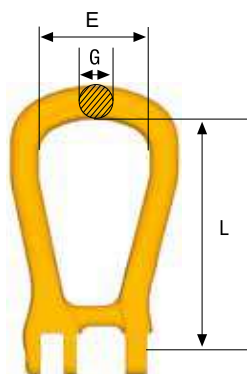

Master Link SKG (closed)

Art. no.	Code	WLL tonnes*	For chain dim.	L	E	G	Weight kg
Z419684	SKG-7/8-8	2.0	7, 8	99	50	14	0.3
Z419781	SKG-10-8	3.2	10	127	66	18	0.6
Z419888	SKG-13-8	5.4	13	145	72	22	1.1
Z419985	SKG-16-8	8.2	16	175	82	25	1.5
Z420086	SKG-18/20-8	12.8	19	204	105	30	3.0

Fulfills requirements in: EN 1677:2008, ISO 8539:2009, ASTM A952/A952M-02, AS 3776:2015 and SANS 1595:2003.

Master Link SKO (open)

Art. no.	Code	WLL tonnes*	For chain dim.	L	E	G	K	Weight kg
Z418683	SKO-7/8-8	2.0	7, 8	99	50	14	15	0.3
Z418780	SKO-10-8	3.2	10	127	66	18	20	0.6
Z419383	SKO-13-8	5.4	13	145	72	22	25	1
Z419480	SKO-16-8	8.2	16	175	82	25	30	1.5
Z419587	SKO-18/20-8	12.8	19	204	105	30	36	2.9

Fulfills requirements in: EN 1677:2008, ISO 8539:2009, ASTM A952/A952M-02, AS 3776:2015 and SANS 1595:2003.

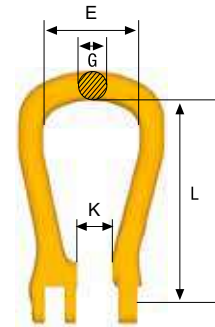

2

Roundsling Coupling SKR

Special shape for full WLL of the roundsling.

Art. no.	Code	WLL tonnes*	L	B	G	K	Weight kg
Z127840	SKR-7/8-8	2.0	35	40	13	18	0.2
Z143143	SKR-10-8	3.2	42	47	16	24	0.4
Z302538	SKR-13-8	5.4	50	53	19	29	0.7
Z143240	SKR-16-8	8.2	62	67	23	35	1.3
Z143347	SKR-18/20-8	12.8	71	80	28	43	1.9
Z100057	SKR-22-8	15.5	111	125	40	50	5.3
Z100055	SKR-26-8	21.7	129	150	48	58	8.9

Fulfills requirements in: EN 1677:2008, ISO 8539:2009, ASTM A952/A952M-02, AS 3776:2015 and SANS 1595:2003.

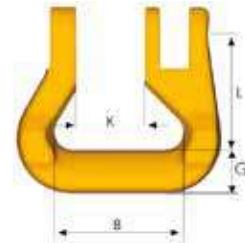

Half-link SKT (incl. locking set)

Art. no.	Code	WLL tonnes*	For chain dim.	L	B	F	A	C	Weight kg
Z426286	SKT-7/8-8	2.0	7, 8	28	18	9	11	22	0.1
Z426383	SKT-10-8	3.2	10	34	25	11	13	26	0.2
Z426480	SKT-13-8	5.4	13	44	30	15	16	33	0.4
Z426587	SKT-16-8	8.2	16	52	36	19	20	40	0.6
Z426684	SKT-18/20-8	12.8	19	63	43	22	23	47	1.1
Z100225	SKT-22-8	15.5	22	76	50	24	26	59	1.7
Z100226	SKT-26-8	21.7	26	80	58	30	33	61	2.6
Z100227	SKT-32-8	32.8	32	100	70	38	40	78	4.9

Fulfills requirements in: EN 1677:2008, ISO 8539:2009, ASTM A952/A952M-02, AS 3776:2015 and SANS 1595:2003.

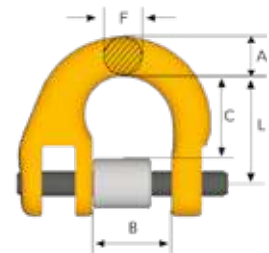

Sling Hook SKN/ESKN with latch

Art. no.	Code	WLL tonnes*	For chain dim.	L	B	G	H	Weight kg
Z424682	SKN-7/8-8	2.0	7, 8	90	27	18	21	0.4
Z424789	SKN-10-8	3.2	10	115	34	23	29	0.8
Z101214	ESKN-13-8	5.4	13	145	42	28	36	1.8
Z100786	ESKN-16-8	8.2	16	178	52	36	43	3.4
Z100781	ESKN-18/20-8	12.8	19	197	54	42	51	5.0

Fulfills requirements in: EN 1677:2008, ISO 8539:2009, ASTM A952/A952M-02, AS 3776:2015 and SANS 1595:2003.

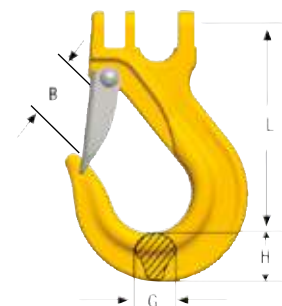

Universal weld-on hook UKN

The original excavator hook

Excavators are often used for material handling and lifting as they are frequently available on most construction sites. However, rigging gear is often incorrectly attached either to the teeth of the bucket or directly on the excavator arm, which is a dangerous practice that can lead to accidents.

Back in 1975 Gunnebo Industries developed the UKN hook, a solution that transformed the excavator into a lifting crane. The UKN hook has been fitted to excavators, and other applications, for over 40 years, either as an aftermarket product or directly by the manufacturer. Today the UKN is the hook of choice for leading international excavator manufacturers.



Quality is top priority

- Forged alloy steel
- Hardened and tempered

100% Proof-loaded

- Every hook is individually proof-loaded at 3 x WLL.

High durability

- Forged
- Rated with a 5:1 safety factor

Clear markings

- Country of origin
- Traceability code
- Model and size

Prepared for welding

- Base plate prepared for welding



Heavy duty latch

- Latch with handles for easy opening
- Hardened and tempered

Pin & spring

- Spring protection
- Hardened and tempered hinge pin
- Stainless steel spring

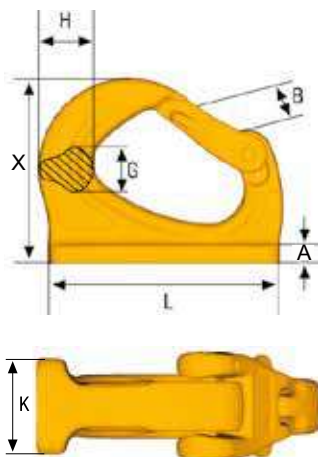

Universal Weld-On Hook - UKN

Art. no.	Code	WLL tonnes**	B	G	H	K	L	A	X	Weight kg
Z1002560	UKN-0,75*	0.75	20	13	20	19	81.5	5	56	0.2
Z6511810	UKN-1*	1.0	27	17	25	25	95	6	72	0.6
Z7009060	UKN-2*	2.0	33	20	30	30	114	8	86	0.9
Z6455730	UKN-3	3.0	30	23	32	35	132	10	105	1.3
Z6521160	UKN-4	4.0	30	29	38	42	140	11	114	2.0
Z6455800	UKN-5	5.0	34	30	47	45	165	12	131	3.2
Z6515390	UKN-8	8.0	34	40	51	50	172	13	133	3.6
Z6456030	UKN-10	10.0	47	43	58	55	220	14	170	8.2
Z1007850	UKN-15	15.0	55	50	67	60	240	15	188	9.8
Z1007851	UKN-20	20.0	65	60	85	60	275	15	207	12.4

* Welding plate slightly curved

** Safety factor 5:1

Fulfills requirements in: EN 474-1 :2006

Master Link MF

Art. no.	Code	WLL (SF 5:1) tonnes		L	E	D	Weight kg
		EN1677-4	A-952/A952M				
Z100860	MF-86-10	2.5	3.2	125	70	14	0.4
Z100861	MF-108-10	4.0	5.2	140	80	17	0.8
Z100862	MF-1310-10	7.5	8.0	160	95	22	1.5
Z100863	MF-1613-10	10.0	13.6	190	110	28	2.5
Z100864	MF-2016-10	17.0	20.6	240	140	34	5.2
Z100865	MF-2220-10	25.0	30.9	250	150	40	7.3

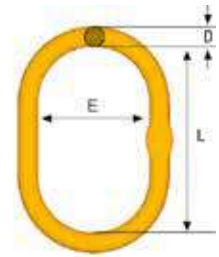

Fulfills requirements in: EN 1677:2008 (WLL +25%), ASTM A952/A952M-02 and AS 3776:2015.

2

Master Link with Sub Links MT

Flattened section on the sublinks.

Art. no.	Code	WLL (SF 5:1) tonnes		For chain 3-4-leg	L1	L	E	D	l	e	d	Weight kg
		EN1677-4	A-952/A952M									
Z100888	MT-6-10	3.5	5.0	6	270	150	90	19	125	70	14	1.8
Z100889	MT-8-10	5.2	8.0	7,8	300	160	95	22	140	80	17	3.0
Z100890	MT-10-10	11.5	16.0	10	360	200	120	30	160	95	22	6.4
Z100891	MT-13-10	17.0	26.0	13	440	250	150	40	190	110	28	14.2
Z100892	MT-16-10	28.0	35.0	16	500	300	200	50	200	120	32	23

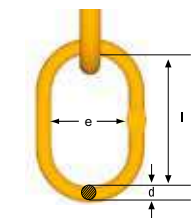
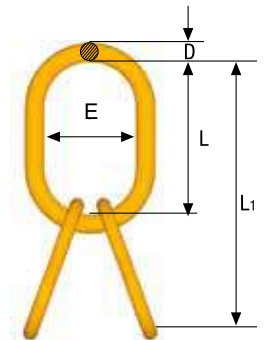

Fulfills requirements in: EN 1677:2008 (WLL +25%), ASTM A952/A952M-02 and AS 3776:2015.

Coupling Link G

Art. no.	Code	WLL tonnes*	For chain dim.	L	B	F	A	C	Weight kg
Z622882	G-6-8	1.1	6	45	15	7	8	17	0.1
Z279333	G-7/8-8	2.0	7,8	56	18	9	11	22	0.2
Z279430	G-10-8	3.2	10	68	25	11	13	26	0.3
Z279537	G-13-8	5.4	13	89	30	15	16	33	0.7
Z279634	G-16-8	8.2	16	105	36	19	20	40	1.2
Z279731	G-18/20-8	12.8	19	125	43	22	23	47	1.9
Z279838	G-22-8	15.5	22	152	50	24	26	59	3.0
Z349171	G-26-8	21.7	26	161	58	30	33	61	5.2
Z349189	G-32-8	32.8	32	200	70	38	40	77	9.5

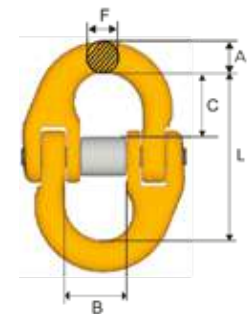

Fulfills requirements in: EN 1677:2008, ISO 8539:2009, ASTM A952/A952M-02, AS 3776:2015 and SANS 1595:2003.

Berglok Chain Coupler BL

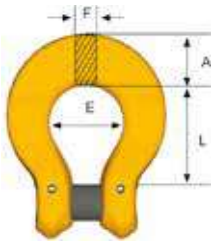

Art. no.	Code	WLL tonnes*	For chain dim.	L	E	F	A	Weight kg
Z622036	BL-6-8	1.1	6	27	20	9	14	0.1
Z195823	BL-7/8-8	2.0	7, 8	35	25	11	18	0.2
Z208022	BL-10-8	3.2	10	45	32	14	22	0.4
Z217820	BL-13-8	5.4	13	56	40	17	28	0.8
Z208226	BL-16-8	8.2	16	68	50	22	35	1.4

Fulfills requirements in: EN 1677:2008, ISO 8539:2009, ASTM A952/A952M-02, AS 3776:2015 and SANS 1595:2003.

Chain, Classic Grade 8

Short link, KL

Heat treatment
Hardened and tempered.

Heat treatment
Painted black (KLB)
Painted yellow (KLU)

Fulfills the requirements in:
EN 818-2:2008, AS 2321:2014,
ASTM A391/A 391M-07 (2012)



Art. no. Box	Code	WLL tonnes*	d nom.	P	w1	Weight kg/m	Manufacturing proof force kN	Breaking force kN
Z802174 - 1 x 200 m	KLB 6-8E	1.1	6	18	8.5	0.8	28.3	45.2
Z802175 - 1 x 200 m	KLB 7-8E	1.5	7	21	10.0	1.1	38.5	62
Z802176 - 1 x 200 m	KLB 8-8E	2.0	8	24	11.0	1.4	50.3	80.6
Z802156 - 1 x 100 m	KLB 10-8E	3.2	10	30	14.0	2.3	79	130
Z802157 - 1 x 100 m	KLB 13-8E	5.4	13	39	17.7	3.8	133	214
Z802177 - 1 x 100 m	KLB 16-8E	8.2	16	48	21.9	5.6	201	322
Z801203 - 1 x 100 m	KLB 19-8E	11.6	19	57	27.0	7.8	284	457
Z801228 - 1 x 50 m	KLB 22-8E	15.5	22	66	29.5	10.6	380	610
Z801231 - 1 x 50 m	KLB 26-8E	21.6	26	78	35.0	14.8	531	850
Z801232 - 1 x 25 m	KLB 32-8E	32.8	32	96	41.6	21.6	804	1300

Grab Hook OG

Not for use with Berglok. No reduction of working load limit, thanks to supporting lugs on either side of hook to prevent chain link deformation.

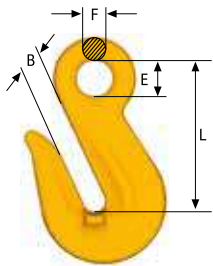

Art. no.	Code	WLL tonnes*	For chain dim.	L	B	E	F	Weight appr. kg
Z100811	OG-7/8-8	2.0	7, 8	65	10	16	10	0.3
Z291022	OG-10-8	3.2	10	85	12	20	12	0.6
Z295220	OG-13-8	5.4	13	104	15	25	16	1.2
Z296221	OG-16-8	8.2	16	130	19	30	19	2.4

Fulfills requirements in: EN 1677:2008, ISO 8539:2009, ASTM A952/A952M-02 and AS 3776:2015.

Safety Hook BKG

Art. no.	Code	WLL tonnes*	For chain dim.	L	B	G	H	Weight appr. kg
Z297222	BKG-7/8-8	2.0	7, 8	120	37	17	26	0.9
Z295929	BKG-10-8	3.2	10	143	45	21	30	1.5
Z291527	BKG-13-8	5.4	13	179	55	30	39	2.8
Z291624	BKG-16-8	8.2	16	217	62	37	48	5.1

Fulfills requirements in: EN 1677:2008, ISO 8539:2009, ASTM A952/A952M-02, AS 3776:2015 and SANS 1595:2003.

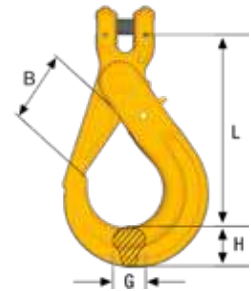

2

Sling Hook EGKN with latch

Art. no.	Code	WLL tonnes*	For chain dim.	L	B	G	H	Weight appr. kg
Z100744	EGKN-7/8-8	2.0	7, 8	95	29	17	22	0.5
Z100772	EGKN-10-8	3.2	10	121	37	20	29	0.9
Z100773	EGKN-13-8	5.4	13	147	42	27	36	2.0
Z100774	EGKN-16-8	8.2	16	170	52	34	44	3.6

Fulfills requirements in: EN 1677:2008, ISO 8539:2009, ASTM A952/A952M-02, AS 3776:2015 and SANS 1595:2003.

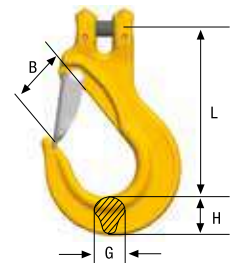

Container Hook BKGK

Art. no.	Code	WLL tonnes*	For chain dim.	L	B	G	H	Weight kg
Z100242	BKGC-16-8	8.2	16	160	55	27	43	3.4

Spare part: RDOBK

Fulfills requirements in: EN 1677:2008, ISO 8539:2009, ASTM A952/A952M-02, AS 3776:2015 and SANS 1595:2003.

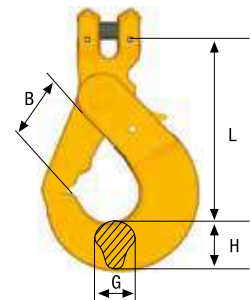

Safety Hook with Griplatch OBK

Art. no.	Code	WLL tonnes*	For chain dim.	A	L	B	E	F	G	H	Weight kg
Z100218	OBK-22-8	15.5	22	30	335	87	70	24	40	58	10.2

Fulfills requirements in: EN 1677:2008, ISO 8539:2009, ASTM A952/A952M-02 and AS 3776:2015.

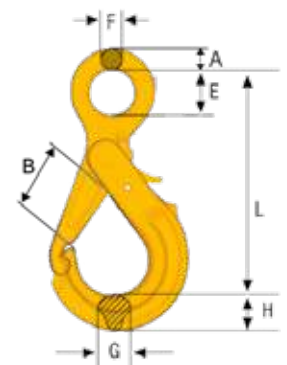

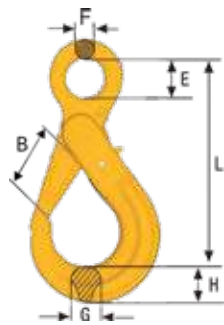

Safety Hook BK

Art. no.	Code	WLL tonnes*	For chain dim.	L	B	E	F	G	H	Weight kg
Z101357	BK-32-8	32.8	32	400	120	90	30	62	86	23.8

Fulfills requirements in: EN 1677:2008, ISO 8539:2009, ASTM A952/A952M-02, AS 3776:2015 and SANS 1595:2003.

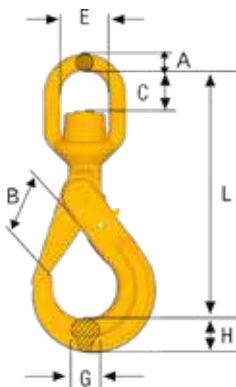

Swivel Safety Hook BCLK

Safety hook with ball-bearing for 360° rotation under full load.

Art. no.	Code	WLL tonnes*	For chain dim.	L	B	C	E	A	G	H	Weight kg
Z101344	BCLK-32-8	32.8	32	533	120	110	102	45	62	86	32.3

Fulfills requirements in: EN 1677:2008, ISO 8539:2009, ASTM A952/A952M-02, AS 3776:2015 and SANS 1595:2003.

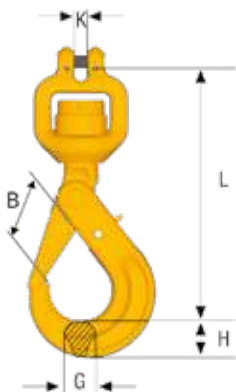

Clevis Swivel Safety Hook BKH

Safety hook with swivel for improved positioning of the hook before the load is lifted (360° rotation).

Art. no.	Code	WLL tonnes*	For chain dim.	L	B	K	G	H	Weight kg
Z336222	BKH-6-8	1.1	6	145	29	6.8	15	21	0.7
Z700809	BKH-7/8-8	2.0	7 - 8	181	37	8.8	17	26	1.2

Fulfills requirements in: EN 1677:2008, ISO 8539:2009, ASTM A952/A952M-02, AS 3776:2015 and SANS 1595:2003.

Sling Hook EK (without latch) and EKN (with latch)

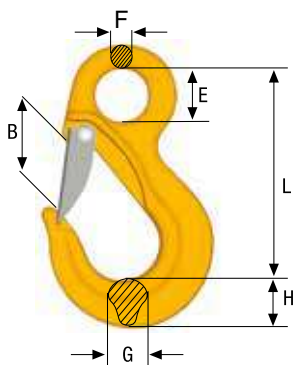

Art. no.	Code	WLL tonnes*	For chain dim.	L	B	E	F	G	H	Weight kg
----------	------	-------------	----------------	---	---	---	---	---	---	-----------

EN 1677-2

Z100720	EK-32-8	32.8	32	333	105	76	38	61	80	17.7
Z100725	EKN-32-8	32.8	32	333	93	76	38	61	80	17.9

Fulfills requirements in: EN 1677:2008, ISO 8539:2009, ASTM A952/A952M-02, AS 3776:2015 and SANS 1595:2003.

DIN 7540 - Also available in ROV version on request

Z101382	DK-50T-8	50.0		442	124	84	50.5	89	116	45.5
Z101361	DKN-50T-8	50.0		442	124	84	50.5	89	116	46.0
Z101384	DK-80T-8	80.0		610	155	102	63	110	145	79.5
Z101363	DKN-80T-8	80.0		610	155	102	63	110	145	80.0

Fulfills requirements in: EN 1677:2008, ISO 8539:2009, ASTM A952/A952M-02, AS 3776:2015 and SANS 1595:2003.

Foundry Hook OKE

Art. no.	Code	WLL tonnes*	For chain dim.	L	B	E	F	G	H	Weight Appr. kg
Z645564	OKE-32-8	32.8	32.8	384	145	90	42	77	94	30

Fulfills requirements in: EN 1677:2008, ISO 8539:2009, ASTM A952/A952M-02, AS 3776:2015 and SANS 1595:2003.

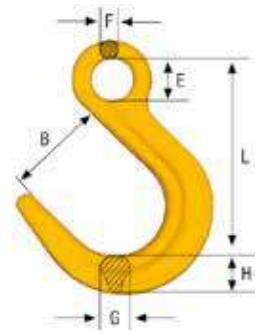

2

Clevis Shackle GSA

Grade 8 EN 1677-1
 Finish: Painted yellow
 Material: Alloy steel
 Safety factor: 4:1

Art. no.	Code	WLL tonnes	For chain dim.	a	c	d2	l	d1	Weight kgs appr.
Z700882	GSA-7/8-8	2.0	7, 8	32	36	34	60	16	0.4
Z700883	GSA-10-8	3.2	10	34	48	40	80	20	0.8
Z700884	GSA-13-8	5.4	13	50	65	44	98	22	1.4
Z700885	GSA-16-8	8.2	16	60	70	54	114	27	2.4

Split pin included.

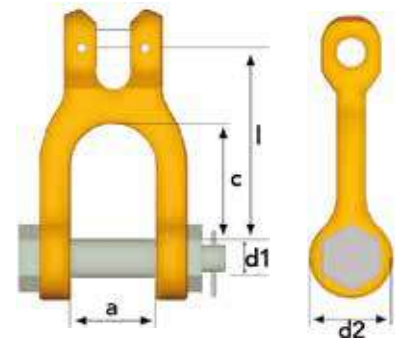

Coupling Link GF Stain Proof**

High strength stainless steel.

Art. no.	Code	WLL tonnes*	For chain dim.	L	B	F	A	C	Weight. kg
B80202	GF-10-8 SP	3.2	10	68	25	11	13	26	0.3
B80203	GF-13-8 SP	5.4	13	89	30	15	16	33	0.7
B80204	GF-16-8 SP	8.2	16	105	36	19	20	40	1.2

**This product comes with a straight pin without recession.

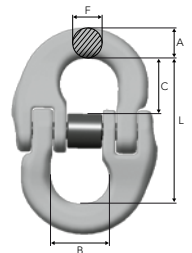

Hot Dip Galvanized lifting range Grade 8

The HDG lifting range is designed to meet the specific challenges from corrosive environments in which they will have a longer lifetime. They require less maintenance than standard products, which means that the HDG products are more cost effective in the long run.

A longer life span

The HDG coating prolongs the life time for equipment in corrosive environments significantly. Not just in costal and maritime areas but also in industrial plants and buildings with high humidity.

Protective coating with high impact and wear resistance

The HDG coating forms a flexible metallurgical bond with the steel, which gives outstanding resistance to mechanical damage during transport and service. The coating also provides an automatic protection to small areas of exposed steel, which means that minor damages need no touch-up.

Easy inspections and lower maintenance costs

Our HDG lifting components are easily visually inspected; if the coating appears sound and continuous, then it is. Simple and quick means improved productivity.

We are a provider of Peace of mind

Production and galvanizing of products that are sensitive for hydrogen embrittlement requires an in-depth material- and process knowledge.

Each element within the manufacturing process is stringently controlled with our in-house quality systems; this also applies to our galvanizing and heat treating procedures which are critical factors in the product performance. Our products are manufactured to exact demands and with preventive actions taken to avoid hydrogen embrittlement in the material.

Technical information

Standards:	Quality assurance:	What is hot dip galvanizing (HDG)?:
<ul style="list-style-type: none"> EN 1677-1:2008 EN 1677-3:2008 EN 1677-4:2008 EN 818-1:2008 EN 818-2:2008 (material dim. Ø +10%) AS2321:2014 ASTM A391/A391M-07 2012 (material dim. Ø +10%) ISO 1461:2009 Applicable parts of NS9415:2009 	<ul style="list-style-type: none"> Fatigue tested construction. Full traceability back to the raw material. Strict controls throughout the whole process. Measurement of coating thickness on random samples from every batch. 100% proof load of every single component. Visual inspection. 	<ul style="list-style-type: none"> Hot-dip galvanizing is the process of coating steel with a layer of zinc for added corrosion resistance. It involves immersing the steel material in molten zinc through a multi-step galvanizing line. The resulting material is encased in several layers of zinc and zinc-iron alloys, making it extremely tough.
Material:	Temperature range:	Documentation:
<ul style="list-style-type: none"> High tensile steel, hardened and tempered. Hot dip galvanized coating according to ISO 1461-2009. 	-40 °C to 200 °C	Inspection certificate acc. EN-10204 - 3.1



Master Link MF HDG

Art. no.	Code	WLL (SF 5:1) tonnes		L	E	D	Weight kgs
		EN1677-4	A-952/A952M				
BG14481	MF-86-8 HDG	2.0	2.0	125	70	14	0.5
BG14482	MF-108-8 HDG	3.2	3.2	140	80	17	0.8
BG14483	MF-1310-8 HDG	5.4	5.4	160	95	22	1.5
BG14484	MF-1613-8 HDG	8.2	8.2	190	110	28	2.8

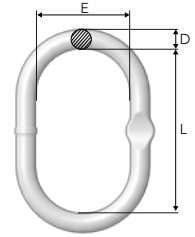

Chain KLZ HDG

Art. no.	Code	WLL tonnes*	d nom.	p	w1	Weight kgs	MPF kN	Breaking force kN	Delivery length
ZG802306	KLZ-6-8 HDG	1.12	6.6	18	8.9	1.0	36.8	45.2	1 x 100 m
ZG802307	KLZ-8-8 HDG	2.0	8.8	24	11.2	1.7	63.0	80.6	1 x 100 m
ZG802308	KLZ-10-8 HDG	3.2	11.0	30	14.4	2.6	98.8	130	1 x 100 m
ZG802309	KLZ-13-8 HDG	5.4	14.3	39	19.2	4.5	166	214	1 x 100 m
ZG802310	KLZ-16-8 HDG	8.2	17.3	48	23.0	6.7	251	322	1 x 100 m



Safety Hook BK HDG

Art. no.	Code	WLL tonnes*	A	L	B	E	F	G	H	Weight kgs
ZG101108	BK-6-8 HDG	1.12	12	109	29	22	10	15	21	0.5
ZG101097	BK-7/8-8 HDG	2.0	14	138	37	28	11	17	26	0.9
ZG101024	BK-10-8 HDG	3.2	16	168	45	34	13	21	31	1.5
ZG101032	BK-13-8 HDG	5.4	20	207	55	44	16	30	40	3.0

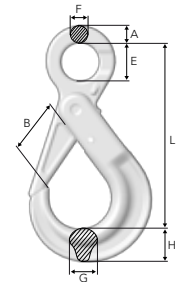

Swivel Safety Hook BKL HDG

Art. no.	Code	WLL tonnes*	L	B	C	E	A	G	H	Weight kgs
ZG101028	BKL-10-8 HDG	3.2	218	45	37	44	15	21	31	2.0
ZG101036	BKL-13-8 HDG	5.4	282	55	49	48	19	30	40	4.0
ZG101044	BKL-16-8 HDG	8.2	344	62	68	61	25	37	50	7.3

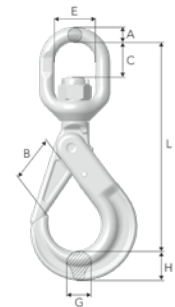

Coupling Link G HDG

Art. no.	Code	WLL tonnes*	L	B	F	A	C	Weight kgs
ZG100821	G-6-8 HDG	1.12	45	15	7	8	17	0.1
ZG100822	G-8-8 HDG	2.0	56	18	9	11	22	0.2
ZG100823	G-10-8 HDG	3.2	68	25	11	13	26	0.3
ZG100824	G-13-8 HDG	5.4	89	30	15	16	33	0.7

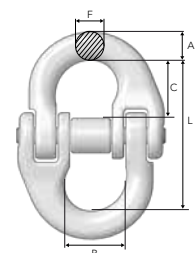

Spare Part BK

Set for BK/BKG safety hooks consisting of trigger, stainless steel spring, retaining pin and assembly kit.



Recessed trigger

Art. no.	Code	Weight kg
Z100282	RDBK-6	0.02
Z100283	RDBK-8	0.03
Z100284	RDBK-10	0.03
Z100285	RDBK-13	0.05
Z100286	RDBK-16	0.10
Z100297	RDBK-18/20	0.21
Z100287	RDBK-22	0.20
Z100280	RDBK-26	0.50
Z100294	RDBK-32	0.70

Standard trigger (long trigger)

Art. no.	Code	Weight kg
Z1002820	RDBK-6	0.01
Z1002830	RDBK-7/8	0.03
Z1002840	RDBK-10	0.03
Z1002850	RDBK-13	0.05
Z1002860	RDBK-16	0.12

Spare Part OBK / GBK

Set for OBK/GBK safety hooks consisting of trigger, stainless steel spring, retaining pin and assembly kit.



Art. no.	Code	Weight kg
Z100281	RDOBK-6	0.01
Z100288	RDOBK-7/8	0.02
Z100289	RDOBK-10	0.03
Z100290	RDOBK-13	0.05
Z100291	RDOBK-16	0.08
Z100297	RDOBK-18/20	0.21
Z100323	RDOBK-22-8	0.35

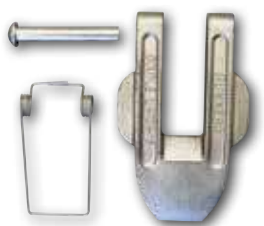

Spare Part BKD / BKLKD

Art. no.	Code	Weight kg
Z101157	RDBKD-13 double latch	0.22
Z101158	RDBKD-16 double latch	0.42
Z101159	RDBKD-18/20 double latch	0.47



Spare Part GKN / OKN

Art. no.	Code	Weight kg
Z622175	RDGKN/OKN-7/8-8	0.05
Z622183	RDGKN/OKN-10-8	0.09
Z622206	RDGKN/OKN-13-8	0.13
Z622214	RDGKN-16-8	0.22



Spare Part LKNG

Art. no.	Code	Weight kg
Z700495	RDLKNG-16 Bolt and Nut	0.7
B60122	RDLKNG-16 Bronze Washer and Retaining pin	0.03

Spare Part GG

Spare part set consisting of pin, spring and locking ring.

Art. no.	Code	Weight kg
B17930	RDGG-8-10 locking pin	0.03
B17931	RDGG-10-10 locking pin	0.04
B17932	RDGG-13-10 locking pin	0.05
B17933	RDGG-16-10 locking pin	0.06



Spare Part LKN / LKNK / EKN / OKN / EGKN / RH / ESKN

Set consisting of latch, stainless steel spring and rivet.

Art.no.	Code	Weight kg
Z100445	RDEKN- 6 / OKN / RH 1	0.03
Z100447	RDEKN- 7/8 /LKN / RH 2	0.05
Z100450	RDEKN-10 / LKN / RH 3	0.06
Z100449	RDEKN-13 / LKN / RH 5	0.13
Z100217	RDEKN-16 / LKN	0.20
Z100453	RDEKN-18/20	0.26
Z100452	RDEKN-22	0.42
Z100742	RDEKN-26	0.53
Z100743	RDEKN-32	0.60



2

Spare Part SKN, OKN and LKN (old version)

Set consisting of latch, stainless steel spring and rivet.

Art. no.	Code	Weight kg
Z420581	RDSKN/LKN-7/8-8	0.05
Z420688	RDSKN/LKN-10-8	0.10
Z420785	RDSKN/LKN-13-8	0.14
Z420989	RDSKN/OKN-16-8	0.22
Z421087	RDSKN/OKN-18/20-8	0.27
Z700698	RDOKN-22-8	0.48



Spare Part UKN

Spare part set RDUKN (msp) consisting of forged latch, pin, stainless steel spring and retaining pin.

Art. no.	Code	Weight kg
Z100258	RDUKN-0.75	0.06
Z700264	RDUKN-1	0.12
Z700958	RDUKN-2	0.20
Z700266	RDUKN-3/4	0.20
Z700268	RDUKN-5/8	0.36
Z700269	RDUKN-10	0.88
Z700984	RDUKN-15/20	1.20



Id-tag grade 8

Stainless steel.

Art.no.	Code
Z100004	Id-tag

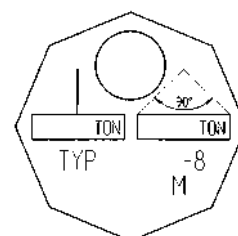

Sling Id-tag Grade 10

Stainless steel.



Art. no.	Code
B14841	Flexitag 6 mm with ferrule and wire
B14842	Flexitag 8 mm with ferrule and wire
B14843	Flexitag 10 mm with ferrule and wire
B14844	Flexitag 13 mm with ferrule and wire
B14845	Flexitag 16 mm with ferrule and wire
Z100971	Flexitag 6 mm
Z100972	Flexitag 8 mm
Z100973	Flexitag 10 mm
Z100974	Flexitag 13 mm
Z100975	Flexitag 16 mm
Z101077	Flexitag 20 mm
Z100899	Flexitag Neutral



Load Pin set CLS

Clevis connection set consisting of one load pin and one spring retaining pin.

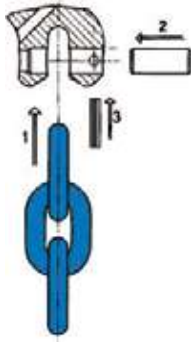

Art. no.	Code	Weight kg
B14930	CLS- 6	0.01
B14931	CLS- 8	0.02
B14932	CLS-10	0.04
B14933R	CLS-13	0.09
B14934	CLS-16	0.16
B14935	CLS-20	0.26

Spare Part CS

C-connection set for CG, CGD, CL, CLD and RH hook, consisting of one blocking pin and one spring retaining pin, for locking.



Art. no.	Code	Weight kg
B14920	CS- 6-10	0.01
B14921	CS- 8-10 / RH-1& -2	0.01
B14922	CS-10-10 / RH-3	0.01
B14923	CS-13-10	0.03
B14924	CS-16-10 / RH-5	0.05

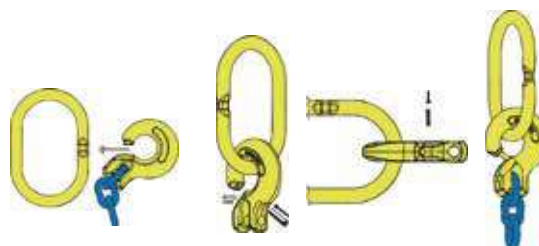

Assembly: C-coupling - C-grab/C-lok with MF

Close/Open Locking set FlexiLeg Quick Pin

Art. no.	Code	Weight kg
Z101010	QP-6-10	0.01
Z101011	QP-8-10	0.01
Z101012	QP-10-10	0.01
Z101013	QP-13-10	0.03
Z101014	QP-16-10	0.06



2

Locking set SKA

SKA locking set for G-link, consists of a load pin and locking collar.

Art. no.	Code	Weight kg	Art. no.	Code	Weight kg
Z100989	SKA- 6-10	0.01	Z700674	SKA-6-8	0.01
Z100933	SKA- 7/8-10	0.02	Z323624	SKA-7/8-8	0.02
Z100934	SKA-10-10	0.04	Z318024	SKA-10-8	0.04
Z100990	SKA-13-10	0.08	Z303822	SKA-13-8	0.08
Z100991	SKA-16-10	0.14	Z303725	SKA-16-8	0.14
Z101176	SKA-20-10	0.26	Z145048	SKA-18/20-8	0.26
Z650555	SKA-22-10	0.35	Z133530	SKA-22-8	0.35
Z650556	SKA-26-10	0.63	Z605407	SKA-26-8	0.63
Z650557	SKA-32-10	1.09	Z650554	SKA-32-8	1.05

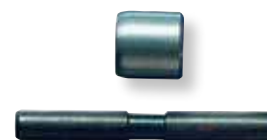

Load Pin set Berglok BLA

Set for Berglok and Clevis type connections.
Consists of one load pin and two retaining pins.

Art. no.	Code	Weight kg
Z275649	BLA-6-8*	0.01
Z275347	BLA-7/8-8*	0.02
Z275444	BLA-10-8	0.04
Z275648	BLA-13-8	0.08
Z276047	BLA-16-8	0.15
Z276241	BLA-19-8	0.26

* Also for Safety hook BKH



Locking set Midgrab MIG

Art. no.	Code	Weight kg
B14904	C-8	0.02
B14905	L-8	0.02
B14914	C-10	0.02
B14915	L-10	0.02
B14916	C-13	0.08
B14917	L-13	0.05



C - Close/open function



L - Permanent locking function

Technical information

The following information aims to give advice and explain the most common questions in order to ensure safe and proper use of lifting equipment.

It is of the utmost importance that this information is known to the user, and in accordance with the Machinery Directive 2006/42/EC this information must be delivered to the customer.

Extreme environments

The in-service temperature effects the WLL as follows:

Temperature (°C)	Reduction of WLL			
	Grade 10 chain (400)	Grade 10 chain (200)	Grade 10 components	Grade 8 chain & components
-40 to +200 °C	0 %	0 %	0 %	0 %
+200 to +300 °C	10 %	Not allowed	10 %	10 %
+300 to +400 °C	25 %	Not allowed	25 %	25 %

Upon return to normal temperature, the sling reverts to its full capacity within the above temperature range. Chain slings should not be used above or below these temperatures.

Note! A chain sling with Grade 10 (200) chain must not be used in temperatures above 200 °C.

- Chain and components must not be used in alkaline (>pH10) or acidic conditions (<pH6).
- Comprehensive and regular examination must be carried out when used in severe or corrosive inducing environments.
- In uncertain situations consult your Gunnebo Industries dealer.

Surface treatment

Note! Hot-dip galvanizing or plating is not allowed outside the control of the manufacturer.

Protect yourself and others

- Before each use the chain sling should be checked for obvious damage or deterioration.
- Know the weight of the load, the center of gravity and ensure it is ready to move and no obstacles will obstruct the lift.
- Check the conformity of the load with the WLL of the ID tag for the specific working configuration. Never use a sling without a legible valid ID tag!
- Prepare the landing site.
- Never overload a sling and avoid shock loading.
- Never use an improper sling configuration.
- Never use a worn out or damaged sling.
- Never ride on the load.
- Never walk or stand under a suspended load.
- Take into consideration that the load may swing or rotate.
- Watch your feet and fingers while loading/unloading.
- Always ensure that your back is clear.

General advice

- Ensure that the sling is precisely as ordered.
- Ensure that the manufacturers certificate is in order.
- Ensure that the ID-tag corresponds to the information on the certificate (the following ID tag information is compulsory: WLL, number of chain legs, nominal size (mm) individual ID-mark, manufacturer, CE-marking and year of manufacturing).
- Ensure that all details of the chain sling are recorded.
- Ensure that the staff using the chain sling has received the appropriate information and training.

Asymmetrical loading conditions

For unequally loaded chain legs we recommend that the WLL are determined as follows:

- 2-leg slings calculated as the corresponding 1-leg sling
- 3 and 4-leg slings calculated as the corresponding 1-leg sling. (If it is certain that 2-legs are equally carrying the major part of the load, it can be calculated as the corresponding 2-leg sling.

Safe use

A chain sling is usually attached to the load and the crane by means of terminal fittings such as hooks, links etc.

When frequently using a sling to it's maximum load, we recommend increasing the sling size by one dimension.



Chain should be without twists or knots, if the chain leg needs length adjustment use a shortening device. The lifting point should be seated well down in the terminal fitting, never on the point or wedged in the opening. The terminal fitting should be free to incline in any direction.

The chain may be passed under or through the load to form a choke hitch or basket hitch. The chain should be allowed to assume it's natural angle and should not be hammered down.

Where choke hitch is employed the WLL of the chain sling should be reduced by 20% (unless the LK choker hook is used)

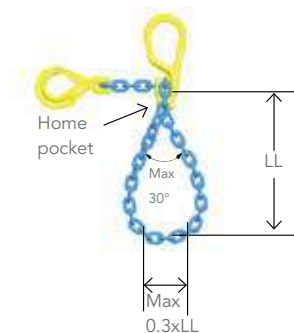

Endless chain slings shall be rated in the same way as a 2-legged sling.

Home pocket loop shall have an internal loop top angle of max. 30°. Rule of thumb: Cross dimension of the load shall be max. 0.3 times the loop length (LL)

Definition: The home pocket is the shortening pocket of the top component directly above the clevis to which the chain is connected.

Sharp edges

Use edge protectors to prevent sharp edges from damaging the chain. If lifting over sharp edges reduce the working load with the following reduction tor.

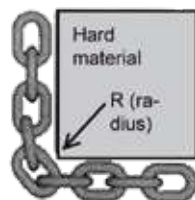

Edge load	$R > 2 \times \text{chain } \varnothing$	$R > \text{chain } \varnothing$	$R < \text{chain } \varnothing$
Reduction factor	1.0	0.7	0.5

- The angle of the edge must not be below 90°.
- Chain links shall be protected from being bent or deformed and from receiving cuts or gouges.
- Chain sling WLL is to be reduced when chain is rigged over an edge radius R less than two (2) x chain diameter (d).
- Reduced WLL equals chain sling WLL from identification tag x reduction factor.
- Slings shall be padded or protected from the edges of their loads when the edge radius is less than 0.5 of the chain diameter(d).
- Slings shall be rigged to prevent chain from sliding over a load edge radius while lifting.
- Slings used in basket hitch shall have the loads balanced to prevent slipping.

When lifting with chain directly on lugs the lug diameter > 3x the pitch of the chain, otherwise the WLL must be reduced by 50%.

Maintenance

Periodic thorough examination must be carried out at least every 12 months or more frequently according to local statutory regulations, type of use and past experience.

1. Overloaded chain slings must be taken out of service.
2. If the lifting equipment is more than 25 years old, it must be recorded in the inspection register. An investigation into both its previous operating history and its current use should be made, as there is a potentially significant risk of fatigue, environmental impact etc.
3. Chain and components including load pins which have been damaged, deformed, elongated, bent or showing signs of cracks or gouges shall be replaced. Carefully grind away small sharp cuts and burrs. Additional testing by magnetic particle inspection and/or proof loading at max. 2 x WLL may be carried out.
4. The maximum permissible increase in hook aperture must not exceed 10% of the products nominal dimension.
5. Check the function of latches, triggers and retaining pins / bushes, replace when necessary. Always use Gunnebo Industries original spare parts.
6. Max. clearance between hook and latch. Note: For a Griplatch hook measure the difference between dimension A with unloaded spring and dimension A when the latch is pressed against the hook. Clearance B not applicable.

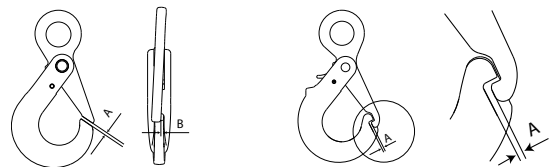

Size	Max. A (mm)	Max. B (mm)
6	2,2	3,5
7/8	2,7	4,5
10	3	6
13	3,3	7
16	4	9
18/20	5,5	10
22	6	11
26	6,5	12
32	7	13

7. The wear of the chain and component shall in no place exceed 10% of the products nominal dimension. The chain link wear is defined and measured as the reduction of the mean diameter measured in two perpendicular directions, see picture.

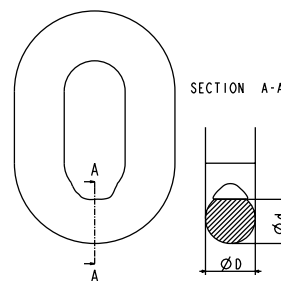

$$\frac{d_1 + d_2}{2} > 0,9d_{nn}$$

d_n = nominal diameter

Quality assurance

Type testing

In order to prove the design, material, heat treatment and method of manufacture, each size of component and chain has been type tested in the finished condition in order to demonstrate that the component and chain possesses the required mechanical properties. The following testing procedures are particularly relevant:

Test for deformation

The Manufacturing Proof Force (MPF) for the relevant size of the component is applied and removed. The dimensions after proof loading shall not alter from the original dimensions within the tolerances prescribed in our specifications and in the international standards.

Static tensile test

The Breaking Force (BF) for each component and size is verified. The verified value shall be at least equal to the Minimum Breaking Force (MBF) value. The MBF value is equal to the Working Load Limit (WLL) multiplied by the safety factor.

Fatigue test

By fatigue testing in pulsator testing machines the toughest conditions of service are simulated.

Manufacturing testing

During manufacture continuous process tests are carried out according to the requirements in our specifications and in the latest international standards. The following testing procedures are particularly relevant:

Non destructive test

3% of every production batch of forged components are subject to magnetic particle or dye penetrating examination.

Proof force / Visual inspection

Each individual forged component and chain link is tested to the Manufacturing Proof Force (MPF) level before delivery. The MPF level is 2.5 times the WLL, equal to 62,5% of the Minimum Breaking Force. Visual inspection is carried out on each chain link and each forged component to detect defects.

Static tensile and ultimate elongation test

During chain manufacturing, samples are tested and the Minimum Breaking Force (MBF) value and the total ultimate elongation are verified.

Bending deflection

During manufacturing, of chain and master links, samples are taken and the minimum bend deflection is verified.

Stress / elongation diagram

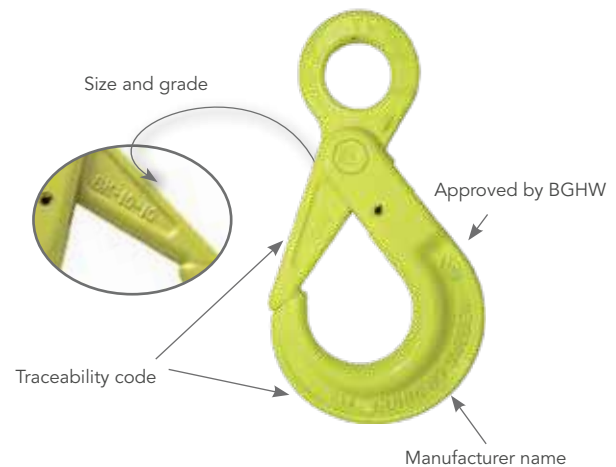
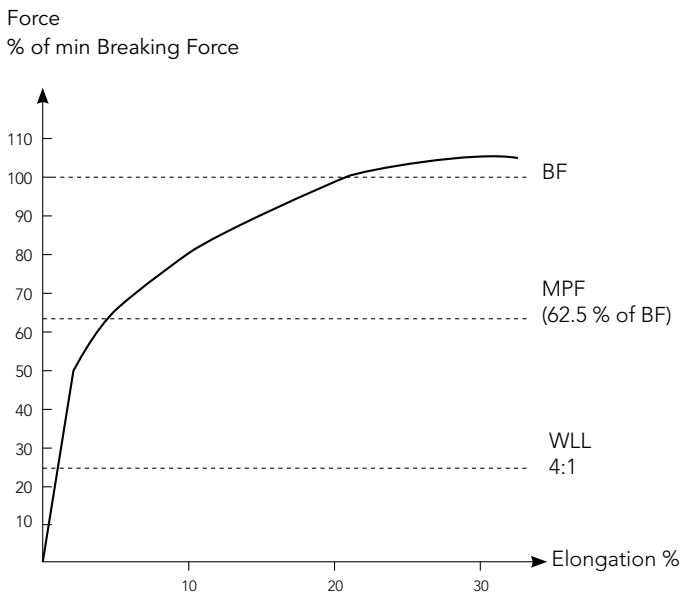



Working load limits - Europe

WLL tonnes Grade 10 GrabiQ

Based on EN 818-4:2008 WLL+25%

Sling type	1-leg		2-leg		3- and 4-leg		Choke Hitch	
	Condition of use	β 0-45° α 0-90°	β 45-60° α 90-120°	β 0-45° α 0-90°	β 45-60° α 90-120°	Choke β 0-45° α 0-90°	Choke β 45-60° α 90-120°	
Load factor	1	1.4	1	2.1	1.5	1.1	0.8	
Chain size								
6	1.50	2.10	1.50	3.10	2.20	1.60	1.20	
7	1.95	2.70	1.95	4.00	2.90	2.10	1.50	
8	2.50	3.50	2.50	5.20	3.70	2.70	2.00	
10	4.00	5.60	4.00	8.40	6.00	4.40	3.20	
13	6.80	9.50	6.80	14.20	10.20	7.40	5.40	
16	10.00	14.10	10.00	21.00	15.00	11.00	8.00	
20	16.00	22.50	16.00	33.60	24.00	17.60	12.80	
22	20.00	28.20	20.00	42.00	30.00	22.00	16.00	
26	27.00	38.00	27.00	56.70	40.50	29.70	21.60	
32	40.00	56.40	40.00	84.00	60.00	44.00	32.00	

Safety factor 4:1. Working load limits are based upon equally loaded and disposed sling legs.

WLL tonnes Grade 8 Classic

EN 818-4:2008

Sling type	1-leg		2-leg		3- and 4-leg		Choke Hitch
	Condition of use	β 0-45° α 0-90°	β 45-60° α 90-120°	β 0-45° α 0-90°	β 45-60° α 90-120°	Endless sling in choke hitch	
Load factor	1	1.4	1	2.1	1.5	1.6	
Chain size							
6	1.12	1.60	1.12	2.36	1.70	1.80	
7	1.50	2.12	1.50	3.15	2.24	2.50	
8	2.00	2.80	2.00	4.25	3.00	3.15	
10	3.15	4.25	3.15	6.70	4.75	5.00	
13	5.30	7.50	5.30	11.20	8.00	8.50	
16	8.0	11.2	8.0	17.0	11.8	12.5	
19	11.2	16.0	11.2	23.6	17.0	18.0	
22	15.0	21.2	15.0	31.5	22.4	23.6	
26	21.2	30.0	21.2	45.0	31.5	33.5	
32	31.5	45.0	31.5	67.0	47.5	50.0	

Safety factor 4:1. Working load limits are based upon equally loaded and disposed sling legs.

Rules for correct WLL

Where choke hitch is employed, the WLL of the chain sling should be reduced by 20 % (unless the LK choker hook is used).

Asymmetrical loading conditions

For unequally loaded chain slings, the following is recommended:

- A two-legged system is treated as a single-legged system.
- A three- or four-legged system is treated as a two-legged system.



Working load limits - United States

WLL tonnes Grade 10 GrabiQ

Based on ASTM A906/A906M-02

Sling type	1-leg	2-leg			3- and 4-leg		
Condition of use	Straight	$\alpha 60^\circ$	$\alpha 45^\circ$	$\alpha 30^\circ$	$\alpha 60^\circ$	$\alpha 45^\circ$	$\alpha 30^\circ$
Load factor	1	1.73	1.41	1	2.59	2.12	1.5
Chain size							
6	1.50	2.50	2.10	1.50	3.80	3.10	2.20
7	1.95	3.40	2.80	1.95	5.10	4.10	2.90
8	2.60	4.50	3.70	2.60	6.70	5.50	3.90
10	4.00	6.90	5.60	4.00	10.40	8.50	6.00
13	6.80	11.80	9.60	6.80	17.70	14.40	10.20
16	10.30	17.70	14.50	10.30	26.60	21.70	15.40
20	16.00	27.70	22.60	16.00	41.60	34.00	24.00
22	19.40	33.60	27.40	19.40	50.30	41.10	29.00
26	27.10	46.80	38.20	27.00	70.60	57.40	40.50
32	40.00	69.30	56.50	40.00	103.90	84.80	60.00

Note 1: WLL for 2-leg sling and single leg basket slings = 2 x 1-leg WLL x sin of horizontal angle α

Note 2: WLL for 3- and 4-leg sling and 2-leg basket slings = 3 x 1-leg WLL x sin of horizontal angle α

Note 3: WLL based upon equally loaded and disposed sling legs

WLL tonnes Grade 8 Classic

Based on ASTM A906/A906M-02

Sling type	1-leg	2-leg			3- and 4-leg		
Condition of use	Straight	$\alpha 60^\circ$	$\alpha 45^\circ$	$\alpha 30^\circ$	$\alpha 60^\circ$	$\alpha 45^\circ$	$\alpha 30^\circ$
Load factor	1	1.73	1.41	1	2.59	2.12	1.5
Chain size							
6	1.12	1.94	1.58	1.12	2.91	2.38	1.68
7	1.57	2.72	2.22	1.57	4.08	3.33	2.36
8	2	3.46	2.83	2.00	5.20	4.24	3.00
10	3.2	5.54	4.53	3.20	8.31	6.79	4.80
13	5.4	9.35	7.64	5.40	14.03	11.46	8.10
16	8.2	14.20	11.60	8.20	21.30	17.39	12.30
19	11.6	20.00	16.30	11.60	30.00	24.50	17.40
22	15.5	26.85	21.92	15.50	40.27	32.88	23.25
26	21.6	37.41	30.55	21.60	56.12	45.82	32.40
32	32.8	56.81	46.39	32.80	85.22	69.58	49.20

Note 1: WLL for 2-leg sling and single leg basket slings = 2 x 1-leg WLL x sin of horizontal angle α

Note 2: WLL for 3- and 4-leg sling and 2-leg basket slings = 3 x 1-leg WLL x sin of horizontal angle α

Note 3: WLL based upon equally loaded and disposed sling legs



Working load limits - Australia

WLL tonnes Grade 10 GrabiQ

Based on AS 3775.2:2014

Sling type	1-leg			2-, 3- and 4-leg				Basket Slings		GrabiQ home pocket loop		
	Straight	Adjustable with no deration	Reeved sling (Choke)	Straight 60°	Straight 90°	Straight 120°	Reeved (Choke) Max angle 60°	1-leg	2-leg	1-leg α max 30°	2-,3- and 4-leg 60° α max 30°	2-,3- and 4-leg 90° α max 30°
Load factor	1	1	0.75	1.73	1.41	1	1.3	1.3	2.25	1	1.73	1.4
Chain size												
6	1.50	1.50	1.10	2.50	2.10	1.50	1.90	1.90	3.30	1.50	2.50	2.10
7	1.95	1.95	1.40	3.30	2.70	1.95	2.50	2.50	4.30	1.95	3.30	2.70
8	2.50	2.50	1.80	4.30	3.50	2.50	3.20	3.20	5.60	2.50	4.30	3.50
10	4.00	4.00	3.00	6.90	5.60	4.00	5.20	5.20	9.00	4.00	6.90	5.60
13	6.80	6.80	5.10	11.70	9.50	6.80	8.80	8.80	15.30	6.80	11.70	9.50
16	10.00	10.00	7.50	17.30	14.10	10.00	13.00	13.00	22.50	10.00	17.30	14.00
20	16.00	16.00	12.00	27.60	22.50	16.00	20.80	20.80	36.00	-	-	-
22	20.00	20.00	15.00	34.60	28.20	20.00	26.00	26.00	45.00	-	-	-
26	27.00	27.00	20.20	46.70	38.00	27.00	35.10	35.10	60.70	-	-	-
32	40.00	40.00	30.00	69.20	56.40	40.00	52.00	52.00	90.00	-	-	-

2

Note 1: Advice regarding the appropriate deration should be sought by the manufacturer

Note 2: The determination of the angle of the multi-leg sling is the largest angle at the apex of the configuration

Note 3: Reeved (choke) slings and basket slings, in a two leg configuration have a maximum angle for us of 60°

Note 4: In the 2-leg basket sling, the master link to be used shall be of an appropriate WLL and with intermediate links. This ensures that the factor 2,25 can be accommodated and that there is no overcrowding with back hooking.

Note 5: For engineered lifts, see Clause 7.2.2 in AS 3775.2:2014

WLL tonnes Grade 8 Classic in Australia

Based on AS 3775.2:2014

Sling type	1-leg				2-, 3- and 4-leg				2-leg
	Straight	Adjustable with no deration	Reeved sling (Choke)	Basket Max angle 60°	Straight β 60°	Straight β 90°	Straight β 120°	Reeved (Choke) Max angle 60°	Basket
Load factor	1	1	0.75	1.3	1.73	1.41	1	1.3	2.25
Chain size									
6	1.10	1.10	0.80	1.40	1.90	1.50	1.10	1.40	2.40
7	1.50	1.50	1.10	1.90	2.50	2.10	1.50	1.90	3.30
8	2.00	2.00	1.50	2.60	3.40	2.80	2.00	2.60	4.50
10	3.20	3.20	2.40	4.10	5.50	4.50	3.20	4.10	7.20
13	5.40	5.40	4.00	7.00	9.30	7.60	5.40	7.00	12.10
16	8.00	8.00	6.00	10.40	13.80	11.20	8.00	10.40	18.00
19	11.60	11.60	8.70	15.00	20.00	16.30	11.60	15.00	26.10
20	12.50	12.50	9.30	16.20	21.60	17.60	12.50	16.20	28.10
22	15.50	15.50	11.60	20.10	26.80	21.80	15.50	20.10	34.80
26	21.60	21.60	16.20	28.00	37.30	30.40	21.60	28.00	48.60
32	32.80	32.80	24.60	42.60	56.70	46.20	32.80	42.60	73.80

Note 1: Advice regarding the appropriate deration should be sought by the manufacturer

Note 2: The determination of the angle of the multi-leg sling is the largest angle at the apex of the configuration

Note 3: Reeved (choke) slings and basket slings, in a two leg configuration have a maximum angle for us of 60°

Note 4: In the 2-leg basket sling, the master link to be used shall be of an appropriate WLL and with intermediate links. This ensures that the factor 2,25 can be accommodated and that there is no overcrowding with back hooking.

Note 5: For engineered lifts, see Clause 7.2.2 in AS 3775.2:2014

Lifting Points

Rotating • Ball-bearing • De-centered • Weldable • Screw-on

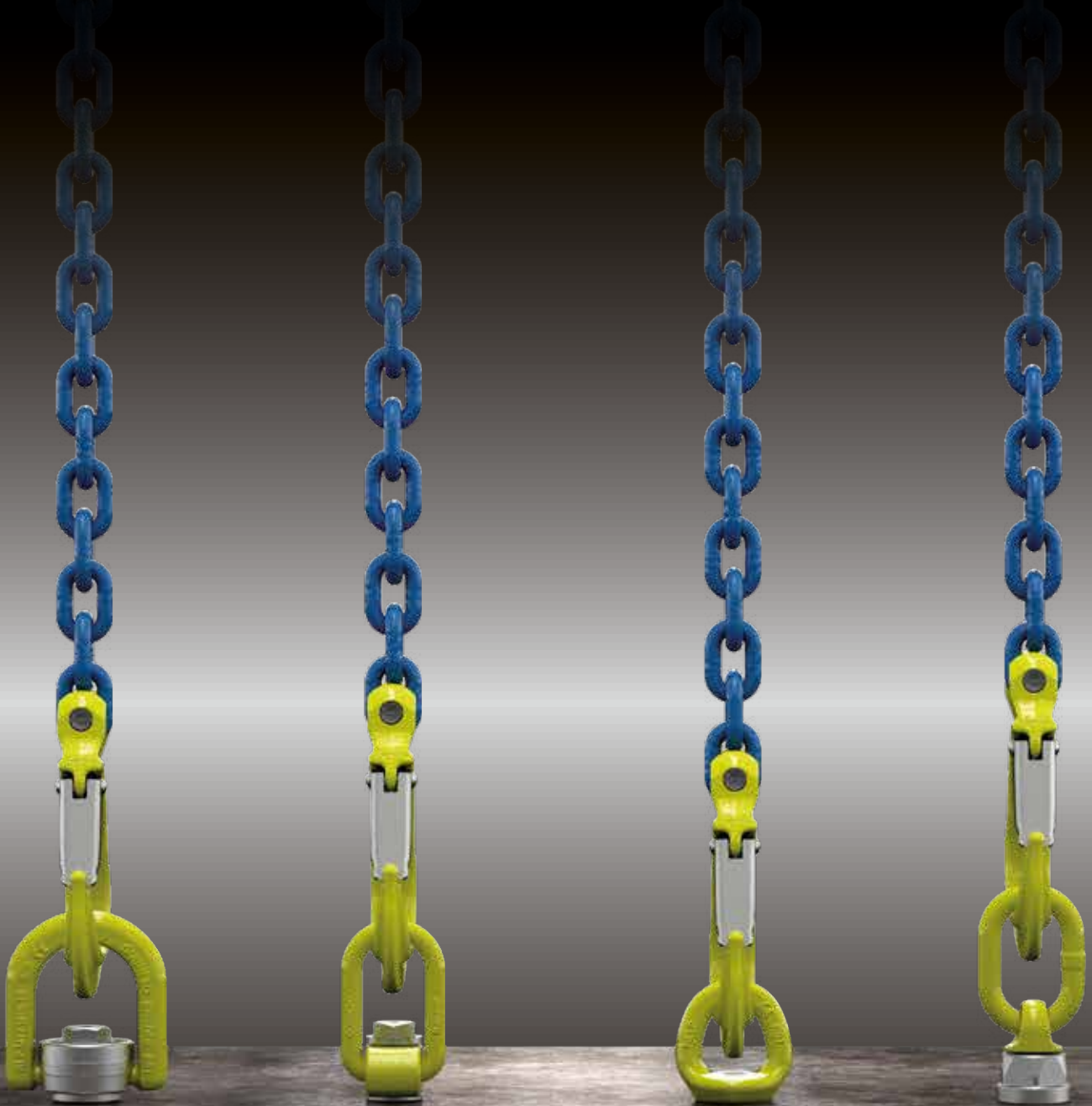

GUNNEBO
Industries

Lifting Points

Lifting Points information	3:2
Rotating Eye Lifting Point RELP	3:4
Rotating Lifting Point RLP	3:5
Decentered Lifting Point DLP	3:6
Ball-bearing Lifting Point BLP	3:7
Master Link D	3:8
Weldable Lifting Point WLP	3:8
Screw-on Lifting Point SLP	3:8
Eye Lifting Point ELP	3:8
Spare Parts	3:9 - 3:10

Technical Information

Instructions for safe use	3:11 - 3:12
Working Load Limits	3:13

The lifting point family

Gunnebo Industries offer a full range of CE-marked lifting points that will fit most lifting and lashing applications.

Choosing the right lifting point for your operation can be a challenge since most lifting points can be used for several purposes. In order to give some guidance, and to share what we consider to be best practice, we have created a cross-chart that provide indications to which lifting point that might be best suited for your specific purpose.

Rotating eye lifting point RELP

The RELP is a compact and robust lifting point, ideal for top-mounting and when it is important to have quick and easy on-hooking. The lifting point is easy to assemble/disassemble with a standard allen key. On the bolt itself working load limit, mounting torque and manufacturing ID is stamped, so it is always available for the operator.

The RELP will automatically adjust to the loading direction which decreases the risk to load it incorrectly and endangering the lifting operation. For sensitive load surfaces the RELP is ideal, as the connecting sling hook will be positioned mainly parallel to the load surface, thus completely avoiding the hook causing damage on impact on the load.



Rotating lifting point RLP

The RLP has an easily dismantlable D-ring to enable assembly of wiresling, master link or hook directly onto the lifting point.

RLP has a hexagon bolt (RFID prepared) to make it easy to disassemble/assemble with a wrench. The bolt is also clearly marked with working load limit, mounting torque and manufacturer ID so it is always available to the operator. The RLP rotates 360° and pivots 180°, making it strong, flexible and reliable.



De-centered lifting point DLP

The design of the DLP allows the link to be folded over the housing when idle, allowing the lifting point to be almost completely stowed away when not in use.

The closed, oblong link is also equipped with a "stay-up"-function for easy on-hooking, (sizes up to M24) especially when there is limited space. This saves both the load from damage due to impacts from the hook, as well as making rigging fast and easy. The DLP is ideal in narrow spaces, such as corners or edge position, as the housing has a compact design. DLP has a hexagon bolt (RFID prepared) to make it easy to disassemble/assemble with a wrench. The bolt is also clearly marked with working load limit, mounting torque and manufacturer ID so it is always available to the operator.



Ball-bearing lifting point BLP

The BLP is a very versatile lifting point and can safely be used for most applications. The ball-bearings in the BLP allow the load to be rotated during the lift, which is especially good when maintenance is needed on heavy tools and other types of equipment.

If the load surface is sensitive to impacts or scratches, the BLP is a good choice as it builds out from the load which makes it less likely that the lifting equipment will come in contact with it causing damage. The housing (RFID prepared) of the BLP is in-house drop-forged for increased strength and has a hexagon shape for easy mounting and dismounting. The housing is also clearly marked with working load limit, mounting torque and manufacturer ID so it is always available to the operator.





	RELP	RLP	DLP	BLP
Tight space	✓		✓	✓
Limited height (effective length)	✓	✓		
Vertical lift	✓	✓		✓
Angular lift		✓	✓	✓
Vertical rotation under load				✓
Tilting under load		✓	✓	✓
Sensitive load surface				✓
Single part lift	✓	✓		✓
Multiple part lift		✓	✓	✓
Integrated combination (hook or link)		✓		
RFID prepared		✓	✓	✓

This chart is intended to give guidance in choosing the right lifting point for your operation and is not rules for usage. For further advice contact your closest Gunnebo Industries dealer.

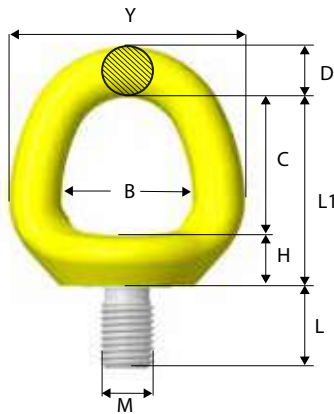

Rotating eye lifting point RELP



Art. no.	Code	Dimensions in mm										Weight kg
		B	C	D	E	H	L	L1	M	Y	Z	
Z102408	RELPM8 x 1.25	28	28	11	40	14	15	42	8	50	29	0.2
Z102410	RELPM10 x 1.5	28	28	11	40	14	15	42	10	50	29	0.2
Z102412	RELPM12 x 1.75	32	33	13	46	13	20	47	12	58	38	0.3
Z102416	RELPM16 x 2	39	41	15	53	16	24	57	16	70	40	0.5
Z102420	RELPM20 x 2.5	42	43	16	60	18	30	60	20	78	46	0.7
Z102424	RELPM24 x 3	50	51	19	68	20	36	71	24	88	44	1.1
Z102430	RELPM30 x 3.5	60	62	26	85	28	45	90	30	112	64	2.4
Z102436	RELPM36 x 4	72	72	32	97	32	54	104	36	136	74	4.1
Z102442	RELPM42 x 4.5	82	82	38	120	37	63	119	42	158	91	6.7
Z102448	RELPM48 x 5	94	96	43	142	39	72	135	48	180	102	9.9

Bolt according to: ISO 898-1 Class 10.9



RELPM with UNC thread



Art. no.	Code	Dimensions in mm										M inch	Weight kg
		B	C	D	E	H	L	L1	Y	Z			
Z102508	RELPM 5/16"-18 UNC	28	28	11	40	14	15	42	50	29	5/16"	0.2	
Z102510	RELPM 3/8"-16 UNC	28	28	11	40	14	15	42	50	29	3/8"	0.2	
Z102512	RELPM 1/2"-13 UNC	32	33	13	46	13	20	47	58	38	1/2"	0.3	
Z102516	RELPM 5/8"-11 UNC	39	41	15	53	16	24	57	70	40	5/8"	0.5	
Z102520	RELPM 3/4"-10 UNC	42	43	16	60	18	30	60	78	46	3/4"	0.7	
Z102521	RELPM 7/8"-9 UNC	42	43	16	60	18	30	60	78	46	7/8"	0.7	
Z102524	RELPM 1"-8 UNC	50	51	19	68	20	36	71	88	44	1"	1.1	
Z102530	RELPM 1 1/4"-7 UNC	60	62	26	85	28	45	90	112	64	1 1/4"	2.4	
Z102536	RELPM 1 1/2"-6 UNC	72	72	32	97	32	54	104	136	74	1 1/2"	4.1	
Z102542	RELPM 1 3/4"-5 UNC	82	82	38	120	37	63	119	158	91	1 3/4"	6.8	
Z102548	RELPM 2"-4.5 UNC	94	96	43	142	39	72	135	180	102	2"	10.0	

Bolt according to: ISO 898-1 Class 10.9

Working Load Limits* RELPM

Symmetric load (tonnes)

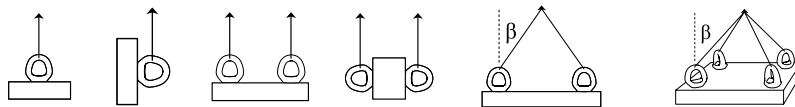

No. of legs	1		2		2 symmetric		3 & 4 symmetric		Tightening torque	Allen key
	Angle β	0°	90°	0°	90°	0-45°	45-60°	0-45°		
RELPM -M8 x 1.25	0.7	0.3	1.4	0.6	0.4	0.3	0.6	0.4	10 Nm	8 mm
RELPM 5/16"-18 UNC	0.7	0.3	1.4	0.6	0.4	0.3	0.6	0.4	7 Ft.Lbs	5/16"
RELPM -M10 x 1.5	1.2	0.5	2.4	1.0	0.7	0.5	1.0	0.7	15 Nm	8 mm
RELPM 3/8"-16 UNC	1.2	0.5	2.4	1.0	0.7	0.5	1.0	0.7	11 Ft.Lbs	5/16"
RELPM -M12 x 1.75	2.0	0.8	4.0	1.6	1.1	0.8	1.6	1.2	27 Nm	8 mm
RELPM 1/2"-13 UNC	2.0	0.8	4.0	1.6	1.1	0.8	1.6	1.2	20 Ft.Lbs	5/16"
RELPM -M16 x 2	3.5	1.5	7.0	3.0	2.1	1.5	3.1	2.2	60 Nm	8 mm
RELPM 5/8"-11 UNC	3.5	1.5	7.0	3.0	2.1	1.5	3.1	2.2	44 Ft.Lbs	5/16"
RELPM -M20 x 2.5	6.1	2.4	12.2	4.8	3.3	2.4	5.0	3.6	90 Nm	8 mm
RELPM 3/4"-10 UNC	5.0	2.3	10.0	4.6	3.1	2.3	4.8	3.4	66 Ft.Lbs	5/16"
RELPM 7/8"-9 UNC	6.1	2.9	12.2	5.8	4.1	2.9	6.1	4.3	66 Ft.Lbs	5/16"
RELPM -M24 x 3	8.1	3.3	16.2	6.6	4.6	3.3	6.9	4.9	135 Nm	19 mm
RELPM 1"-8 UNC	8.1	3.3	16.2	6.6	4.6	3.3	6.9	4.9	100 Ft.Lbs	3/4"
RELPM -M30 x 3.5	12.1	4.6	24.2	9.2	6.4	4.6	9.6	6.9	270 Nm	19 mm
RELPM 1 1/4"-7 UNC	12.1	4.6	24.2	9.2	6.4	4.6	9.6	6.9	200 Ft.Lbs	3/4"
RELPM -M36 x 4	16.1	7.1	32.2	14.2	9.9	7.1	14.9	10.6	320 Nm	19 mm
RELPM 1 1/2"-6 UNC	16.1	7.1	32.2	14.2	9.9	7.1	14.9	10.6	236 Ft.Lbs	3/4"
RELPM -M42 x 4.5	24	9.1	48	18.2	12.7	9.1	19.1	13.6	600 Nm	19 mm
RELPM 1 3/4"-5 UNC	24	9.1	48	18.2	12.7	9.1	19.1	13.6	440 Ft.Lbs	3/4"
RELPM -M48 x 5	32	12.1	64	24.2	16.9	12.1	25.4	18.1	800 Nm	19 mm
RELPM 2"-4.5 UNC	32	12.1	64	24.2	16.9	12.1	25.4	18.1	590 Ft.Lbs	3/4"

Rotating lifting point RLP



Art. no. Standard bolt length	L	Art.no. Long bolt length**	L2	Code	Dimensions in mm								Weight kg***
					B	C	D	L1	M	X	Y	Z	
Z101708	16	Z1017080L	101	RLP-M8 x 1.25	42	35	12	62	8	27	64	Ø40	0.3
Z101710	16	Z1017100L	101	RLP -M10 x 1.5	42	35	12	62	10	27	64	Ø40	0.3
Z101712	25	Z1017120L	120	RLP -M12 x 1.75	57	46	19	88	12	42	91	Ø54	1.0
Z101716	25	Z1017160L	160	RLP-M16 x 2	57	46	19	88	16	42	91	Ø54	1.0
Z101720	36	Z1017200L	200	RLP-M20 x 2.5	83	55	28	110	20	55	133	Ø80	2.9
Z101724	36	Z1017240L	240	RLP-M24 x 3	83	55	28	110	24	55	133	Ø80	2.9
Z101730	58	Z1017300L	300	RLP-M30 x 3.5	114	70	34	148	30	78	182	Ø111	7.1
Z101736	58	Z1017360L	300	RLP-M36 x 4	114	70	34	148	36	78	182	Ø111	7.3
Z101742	81	Z1017420L	301	RLP-M42 x 4.5	149	91	40	190	42	99	229	Ø142	14.3
Z101748	81	Z1017480L	301	RLP-M48 x 5	149	91	40	190	48	99	229	Ø142	14.5

** Long Bolt supplied with nut and washer. *** Weight is calculated with standard bolt length.
Bolt, nut and washer according to: ISO 898-1 Class 10.9

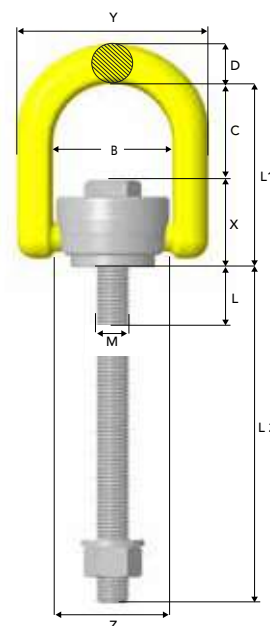

RLP with UNC thread



Art. no. Standard bolt length	L	Art.no. long bolt length**	L2	Code	Dimensions in mm								M inch	Weight kg***
					B	C	D	L1	X	Y	Z			
Z101808	16	Z1018080L	101	RLP-5/16"-18 UNC	42	35	12	62	27	64	Ø40	5/16"	0.3	
Z101810	16	Z1018100L	101	RLP-3/8"-16 UNC	42	35	12	62	27	64	Ø40	3/8"	0.3	
Z101812	25	Z1018120L	120	RLP-1/2"-13 UNC	57	46	19	88	42	91	Ø54	1/2"	1.0	
Z101816	25	Z1018160L	160	RLP-5/8"-11 UNC	57	46	19	88	42	91	Ø54	5/8"	1.0	
Z101820	36	Z1018200L	200	RLP-3/4"-10 UNC	83	55	28	110	55	133	Ø80	3/4"	2.9	
Z101821	36	Z1018210L	200	RLP-7/8"-9 UNC	83	55	28	110	55	133	Ø80	7/8"	2.9	
Z101824	36	Z1018240L	240	RLP 1"-8 UNC	83	55	28	110	55	133	Ø80	1"	2.9	
Z101830	58	Z1018300L	300	RLP 1 1/4"-7 UNC	114	70	34	148	78	182	Ø111	1 1/4"	7.1	
Z101836	58	Z1018360L	300	RLP 1 1/2"-6 UNC	114	70	34	148	78	182	Ø111	1 1/2"	7.3	
Z101842	81	Z1018420L	301	RLP 1 3/4"-5 UNC	149	91	40	190	99	229	Ø142	1 3/4"	14.4	
Z101848	81	Z1018480L	301	RLP 2"-4.5 UNC	149	91	40	190	99	229	Ø142	2"	14.7	

** Long Bolt supplied with nut and washer. *** Weight is calculated with standard bolt length.
Bolt, nut and washer according to: ISO 898-1 Class 10.9

3

Working Load Limits* RLP

Symmetric load (tonnes)	No. of legs						Tightening torque		Spanner size	
	1	1	2	2	2 symmetric	3 & 4 symmetric				
Angle β	0°	90°	0°	90°	0-45°	45-60°	0-45°	45-60°		
RLP - M8 x 1.25	0.8	0.4	1.6	0.8	0.5	0.4	0.8	0.6	10 Nm	13 mm
RLP 5/16"-18 UNC	0.8	0.4	1.6	0.8	0.5	0.4	0.8	0.6	7 Ft.Lbs	1/2"
RLP - M10 x 1.5	1.2	0.7	2.4	1.4	0.9	0.7	1.4	1.0	15 Nm	13 mm
RLP 3/8"-16 UNC	1.2	0.65	2.4	1.3	0.9	0.6	1.3	0.9	11 Ft.Lbs	1/2"
RLP - M12 x 1.75	2.0	1.2	4.0	2.4	1.6	1.2	2.5	1.8	27 Nm	24 mm
RLP 1/2"-13 UNC	2.0	1.2	4.0	2.4	1.6	1.2	2.5	1.8	20 Ft.Lbs	15/16"
RLP - M16 x 2	3.2	2.0	6.4	4.0	2.8	2.0	4.2	3.0	60 Nm	24 mm
RLP 5/8"-11 UNC	3.2	2.0	6.4	4.0	2.8	2.0	4.2	3.0	44 Ft.Lbs	15/16"
RLP - M20 x 2.5	5.6	2.8	11.2	5.6	3.9	2.8	5.8	4.2	90 Nm	32 mm
RLP 3/4"-10 UNC	5.0	2.5	10.0	5.0	3.5	2.5	5.2	3.7	66 Ft.Lbs	1 5/16"
RLP 7/8"-9 UNC	5.6	2.8	11.2	5.6	3.9	2.8	5.8	4.2	66 Ft.Lbs	1 5/16"
RLP - M24 x 3	8.0	4.6	16.0	9.2	6.4	4.6	9.6	6.9	135 Nm	32 mm
RLP 1"-8 UNC	8.0	4.6	16.0	9.2	6.4	4.6	9.6	6.9	100 Ft.Lbs	1 5/16"
RLP - M30 x 3.5	12.0	6.0	24.0	12.0	8.4	6.0	12.6	9.0	270 Nm	55 mm
RLP 1 1/4"-7 UNC	12.0	6.0	24.0	12.0	8.4	6.0	12.6	9.0	200 Ft.Lbs	2 1/4"
RLP - M36 x 4	14.0	8.0	28.0	16.0	11.2	8.0	16.8	12.0	320 Nm	55 mm
RLP 1 1/2"-6 UNC	14.0	8.0	28.0	16.0	11.2	8.0	16.8	12.0	236 Ft.Lbs	2 1/4"
RLP - M42 x 4.5	16.0	14.0	32.0	28.0	19.6	14.0	29.4	21.0	600 Nm	75 mm
RLP 1 3/4"-5 UNC	16.0	14.0	32.0	28.0	19.6	14.0	29.4	21.0	440 Ft.Lbs	3"
RLP - M48 x 5	20.0	16.0	40.0	32.0	22.4	16.0	33.6	24.0	800 Nm	75 mm
RLP 2"-4.5 UNC	20.0	16.0	40.0	32.0	22.4	16.0	33.6	24.0	590 Ft.Lbs	3"



Disassembly of the RLP is easily done by just folding the D-ring forward and push down.

De-centered lifting point DLP

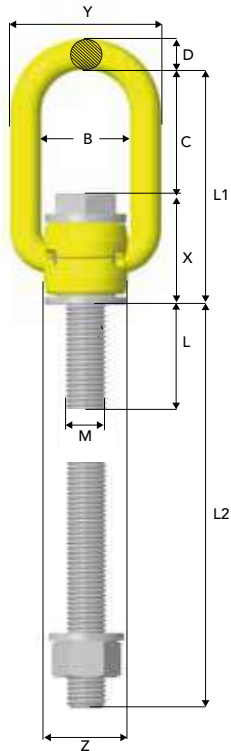

Art. no. Standard bolt length	L	Art.no. Long bolt length**	L2	Code	Dimensions in mm											Weight Kg***
					B	C	D	E	F	G	L1	M	X	Y	Z	
Z102208	13	Z1022080L	97.5	DLP-M8 x 1.25	35	48	10	39	14	10	78	8	30	55	26	0.3
Z102210	13	Z1022100L	97.5	DLP-M10 x 1.5	35	48	10	39	14	10	78	10	30	55	26	0.3
Z102212	23	Z1022120L	118	DLP-M12 x 1.75	35	48	12	51	20	14	91	12	44	59	32	0.5
Z102216	23	Z1022160L	158	DLP-M16 x 2	35	48	12	51	20	14	91	16	44	59	32	0.5
Z102220	34	Z1022200L	198	DLP-M20 x 2.5	54	88	18	71	28	18	145	20	58	90	48	1.6
Z102224	34	Z1022240L	238	DLP-M24 x 3	54	88	18	71	28	18	145	24	58	90	48	1.7
Z102230	53	Z1022300L	295	DLP-M30 x 3.5	82	94	26	104	39	27	182	30	88	122	75	5.0
Z102236	53	Z1022360L	295	DLP-M36 x 4	82	94	26	104	39	27	182	36	88	122	75	5.2
Z102242	73	Z1022420L	293	DLP-M42 x 4.5	100	104	36	136	54	34	216	42	113	156	110	11.6
Z102248	73	Z1022480L	293	DLP-M48 x 5	100	103	36	136	54	34	216	48	113	156	110	11.9

** Long Bolt supplied with nut and washer. *** Weight is calculated with standard bolt length.
Bolt, nut and washer according to: ISO 898-1 Class 10.9

DLP with UNC thread



Art. no. Standard bolt length	L	Art.no. Long bolt length**	L2	Code	Dimensions in mm											M inch	Weight kg***
					B	C	D	E	F	G	L1	X	Y	Z			
Z102308	13	Z1023080L	97.5	DLP-5/16"-18 UNC	35	48	10	39	14	10	78	30	55	26	5/16"	0.3	
Z102310	13	Z1023100L	97.5	DLP-3/8"-16 UNC	35	48	10	39	14	10	78	30	55	26	3/8"	0.3	
Z102312	23	Z1023120L	118	DLP-1/2"-13 UNC	35	48	12	51	20	14	91	44	59	32	1/2"	0.5	
Z102316	23	Z1023160L	158	DLP-5/8"-11 UNC	35	48	12	51	20	14	91	44	59	32	5/8"	0.5	
Z102320	34	Z1023200L	198	DLP-3/4"-10 UNC	54	88	18	71	28	18	145	58	90	48	3/4"	1.6	
Z102321	34	Z1023210L	198	DLP-7/8"-9 UNC	54	88	18	71	28	18	145	58	90	48	7/8"	1.6	
Z102324	34	Z1023240L	238	DLP-1"-8 UNC	54	88	18	71	28	18	145	58	90	48	1"	1.7	
Z102330	53	Z1023300L	295	DLP-1 1/4"-7 UNC	82	94	26	104	39	27	182	88	122	75	1 1/4"	5.5	
Z102336	53	Z1023360L	295	DLP-1 1/2"-6 UNC	82	94	26	104	39	27	182	88	122	75	1 1/2"	5.7	
Z102342	73	Z1023420L	293	DLP-1 3/4"-5 UNC	100	103	36	136	54	34	216	113	156	110	1 3/4"	11.7	
Z102348	73	Z1023480L	293	DLP-2"-4.5 UNC	100	103	36	136	54	34	216	113	156	110	2"	12.1	

** Long Bolt supplied with nut and washer. *** Weight is calculated with standard bolt length.
Bolt, nut and washer according to: ISO 898-1 Class 10.9



Working Load Limits* DLP

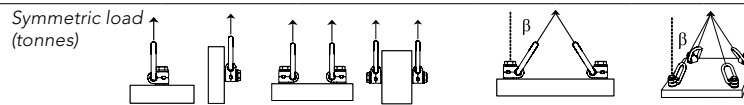

No. of legs	1		2		2 symmetric		3 & 4 symmetric		Tightening torque	Spanner size
	Angle β	$0^\circ < \beta < 90^\circ$	$0^\circ < \beta < 90^\circ$	$0-45^\circ$	$45-60^\circ$	$0-45^\circ$	$45-60^\circ$			
DLP -M8 x 1.25		0.35	0.70	0.5	0.35	0.7	0.5	10 Nm	13 mm	
DLP 5/16"-18 UNC		0.35	0.70	0.5	0.35	0.7	0.5	7 Ft.Lbs	1/2"	
DLP -M10 x 1.5		0.65	1.30	0.9	0.65	1.4	1.0	15 Nm	13 mm	
DLP 3/8"-16 UNC		0.60	1.20	0.8	0.60	1.3	1.0	11 Ft.Lbs	1/2"	
DLP -M12 x 1.75		1.0	2.0	1.4	1.0	2.1	1.5	27 Nm	24 mm	
DLP 1/2"-13 UNC		1.0	2.0	1.4	1.0	2.1	1.5	20 Ft.Lbs	15/16"	
DLP -M16 x 2		1.8	3.6	2.5	1.8	3.7	2.7	60 Nm	24 mm	
DLP 5/8"-11 UNC		1.6	3.2	2.2	1.6	3.3	2.4	44 Ft.Lbs	15/16"	
DLP -M20 x 2.5		2.6	5.2	3.5	2.6	5.4	3.9	90 Nm	32 mm	
DLP -3/4"-10 UNC		2.2	4.4	3.0	2.2	4.6	3.3	66 Ft.Lbs	1 5/16"	
DLP -7/8"-9 UNC		2.6	5.2	3.5	2.6	5.4	3.9	66 Ft.Lbs	1 5/16"	
DLP -M24 x 3		4.1	8.2	5.7	4.1	8.6	6.1	135 Nm	32 mm	
DLP -1"-8 UNC		4.1	8.2	5.7	4.1	8.6	6.1	100 Ft.Lbs	1 5/16"	
DLP -M30 x 3.5		5.0	10.0	7.0	5.0	10.5	7.5	270 Nm	55 mm	
DLP -1 1/4"-7 UNC		5.0	10.0	7.0	5.0	10.5	7.5	200 Ft.Lbs	2 1/4"	
DLP -M36 x 4		7.0	14.0	9.8	7.0	14.7	10.5	320 Nm	55 mm	
DLP -1 1/2"-6 UNC		7.0	14.0	9.8	7.0	14.7	10.5	236 Ft.Lbs	2 1/4"	
DLP -M42 x 4.5		15.0	30.0	21.0	15.0	31.5	22.5	600 Nm	75 mm	
DLP -1 3/4"-5 UNC		15.0	30.0	21.0	15.0	31.5	22.5	440 Ft.Lbs	3"	
DLP -M48 x 5		20.0	40.0	28.0	20.0	42.0	30.0	800 Nm	75 mm	
DLP -2"-4.5 UNC		20.0	40.0	28.0	20.0	42.0	30.0	590 Ft.Lbs	3"	

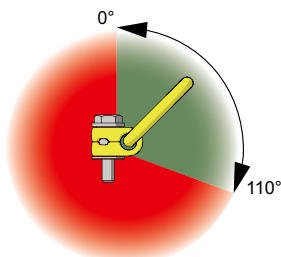

- The DLP can only be loaded from 0° to 110° degrees.
- Rotation around screw axis when loaded at $0^\circ-15^\circ$ is not allowed.

Ball-bearing lifting point BLP



Art. no.	Code	Dimensions in mm										Weight kg
		B	C	D	L	L1	M	X	Y	Z		
Z102008	BLP-M8 x 1.25	35	55	13	16	112	8	57	62	Ø42	0.6	
Z102010	BLP -M10 x 1.5	35	55	13	20	112	10	57	61	Ø42	0.6	
Z102012	BLP -M12 x 1.75	35	55	13	24	112	12	57	61	Ø42	0.6	
Z102016	BLP-M16 x 2	35	55	13	30	112	16	57	61	Ø42	0.6	
Z102020	BLP-M20 x 2.5	34	57	17	30	132	20	75	67	Ø59	1.3	
Z102024	BLP-M24 x 3	50	70	17	36	145	24	75	84	Ø59	1.5	
Z102030	BLP-M30 x 3.5	54	96	22	45	102	30	106	99	Ø74	3.4	
Z102036	BLP-M36 x 4	54	96	22	54	102	36	106	99	Ø74	3.5	
Z102042	BLP-M42 x 4.5	70	120	28	63	242	42	122	127	Ø93	6.5	
Z102048	BLP-M48 x 5	70	120	28	72	242	48	122	127	Ø93	6.8	

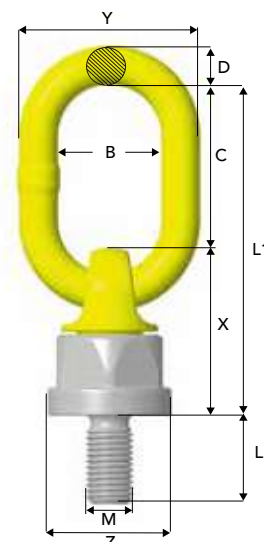

BLP with UNC thread



Art. no.	Code	Dimensions in mm										M inch	Weight kg
		B	C	D	L	L1	X	Y	Z				
Z102108	BLP-5/16"-18 UNC	35	55	13	16	112	57	61	Ø42	5/16"	0.6		
Z102110	BLP-3/8"-16 UNC	35	55	13	20	112	57	61	Ø42	3/8"	0.6		
Z102112	BLP-1/2"-13 UNC	35	55	13	24	112	57	61	Ø42	1/2"	0.6		
Z102116	BLP-5/8"-11 UNC	35	55	13	30	112	57	61	Ø42	5/8"	0.6		
Z102120	BLP-3/4"-10 UNC	34	57	17	30	132	75	67	Ø59	3/4"	1.3		
Z102121	BLP-7/8"-9 UNC	34	57	17	30	132	75	67	Ø59	7/8"	1.3		
Z102124	BLP-1"-8 UNC	50	70	17	38	145	75	84	Ø59	1"	1.5		
Z102130	BLP-1 1/4"-7 UNC	54	96	22	48	202	106	99	Ø74	1 1/4"	3.4		
Z102136	BLP-1 1/2"-6 UNC	54	96	22	57	202	106	99	Ø74	1 1/2"	3.6		
Z102142	BLP-1 3/4"-5 UNC	70	120	28	67	242	122	127	Ø93	1 3/4"	6.6		
Z102148	BLP-2"-4.5 UNC	70	120	28	76	242	122	127	Ø93	2"	7.0		

3

Working Load Limits* BLP

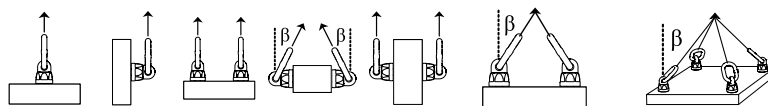

No. of legs	1		2		2 symmetric		3 & 4 symmetric		Tightening torque	Spanner size	
Angle β	0°	90°	0°	0-45°	90°	0-45°	45-60°	0-45°			45-60°
BLP -M8 x 1.25	0.6	0.3	1.2	0.4	0.6	0.4	0.3	0.6	0.45	10 Nm	36 mm
BLP -5/16"-18 UNC	0.6	0.3	1.2	0.4	0.6	0.4	0.3	0.6	0.45	7 Ft.Lbs	1 1/2"
BLP -M10 x 1.5	1.0	0.5	2.0	0.7	1.0	0.7	0.5	1.3	0.75	15 Nm	36 mm
BLP -3/8"-16 UNC	0.8	0.4	1.6	0.5	0.8	0.5	0.4	0.8	0.6	11 Ft.Lbs	1 1/2"
BLP -M12 x 1.75	1.5	0.75	3.0	1.1	1.5	1.1	0.75	1.5	1.1	27 Nm	36 mm
BLP -1/2"-13 UNC	1.5	0.75	3.0	1.1	1.5	1.0	0.75	1.5	1.1	20 Ft.Lbs	1 1/2"
BLP -M16 x 2	3.0	1.5	6.0	2.1	3.0	2.1	1.5	3.1	2.2	60 Nm	36 mm
BLP -5/8"-11 UNC	3.0	1.5	6.0	2.1	3.0	2.1	1.5	3.1	2.2	44 Ft.Lbs	1 1/2"
BLP -M20 x 2.5	5.0	2.5	10.0	3.5	5.0	3.5	2.5	5.2	3.7	90 Nm	50mm
BLP -3/4"-10 UNC	4.5	2.25	9.0	3.1	4.5	3.1	2.25	4.7	3.3	66 Ft.Lbs	2"
BLP -7/8"-9 UNC	6.0	3.0	12.0	4.2	6.0	4.2	3.0	6.3	4.5	66 Ft.Lbs	2"
BLP -M24 x 3	7.0	4.0	14.0	5.6	8.0	5.6	4.0	8.4	6.0	135 Nm	50mm
BLP -1"-8 UNC	7.0	4.0	14.0	5.6	8.0	5.6	4.0	8.4	6.0	100 Ft.Lbs	2"
BLP -M30 x 3.5	12.0	6.0	24.0	8.4	12.0	8.4	6.0	12.6	9.0	270 Nm	65 mm
BLP -1 1/4"-7 UNC	12.0	6.0	24.0	8.4	12.0	8.4	6.0	12.6	9.0	200 Ft.Lbs	2 5/8"
BLP -M36 x 4	14.0	8.0	28.0	11.2	16.0	11.2	8.0	16.8	12.0	320 Nm	65 mm
BLP -1 1/2"-6 UNC	14.0	8.0	28.0	11.2	16.0	11.2	8.0	16.8	12.0	236 Ft.Lbs	2 5/8"
BLP -M42 x 4.5	16.0	10.0	32.0	14.0	20.0	14.0	10.0	21.0	15.0	600 Nm	85 mm
BLP -1 3/4"-5 UNC	16.0	10.0	32.0	14.0	20.0	14.0	10.0	21.0	15.0	440 Ft.Lbs	3 1/8"
BLP -M48 x 5	18.0	13.0	36.0	18.2	26.0	18.2	13.0	27.3	19.5	800 Nm	85 mm
BLP -2"-4.5 UNC	18.0	13.0	36.0	18.2	26.0	18.2	13.0	27.3	19.5	590 Ft.Lbs	3 1/8"

*Safety factor 4:1

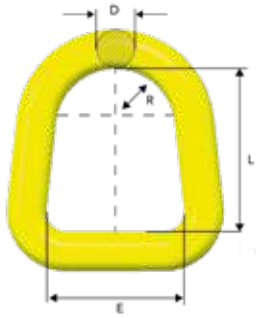

Master link D

CE

Art. no.	Code	WLL tonnes*	E	D	L	R	Weight kg
Z7008771	D-14-10	2.5	55	14	65	24	0.4
Z7008781	D-17-10	4.0	64	17	62	29	0.5
Z7008801	D-22-10	7.0	76	22	90	33	1.0
Z7008791	D-27-10	10.0	85	27	98	38	1.9
Z7008792	D-32-10	16.0	114	32	139	50	3.5

The load bearing width must be at least 0.5 x E.

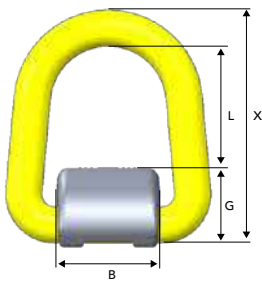

Weldable lifting point WLP

CE

Art. no.	Code	WLL tonnes*	B	G	L	X	Weight kg
Z7009001	WLP-2.5T	2.5	50	27	53	95	0.5
Z7009011	WLP-4T	4.0	58	34	48	97	0.8
Z7009021	WLP-7T	7.0	64	41	73	135	1.8
Z7009031	WLP-10T	10.0	65	52	73	152	3.4
Z7009041	WLP-16T	16.0	90	66	105	203	6.7

Supplied with spring for stay up function.
Master Link measurements, see Master Link D above.
Working Load Limits on page 3:13.

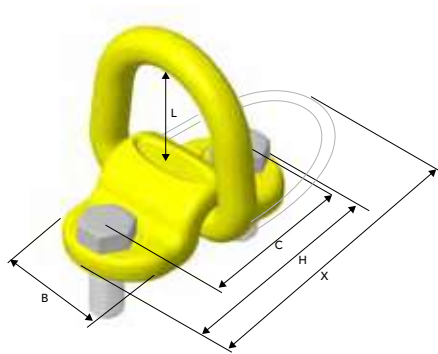

Screw-on lifting point SLP

CE

Art. no.	Code	WLL tonnes*	B	C	H	L	M	X	Bolt protrusion	Weight kg
Z7009881	SLP-1T	1.0	50	72	98	54	M14	139	25	0.8
Z7009871	SLP-3T	3.0	58	84	114	49	M16	144	28	1.3
Z7009861	SLP-5T	5.0	64	116	160	71	M20	203	34	2.6

Supplied with bolt and spring for stay up function.
Bolt according to: ISO 898-1 Class 10.9.
Master Link measurements, see Master Link D above.
Working Load Limits on page 3:13.

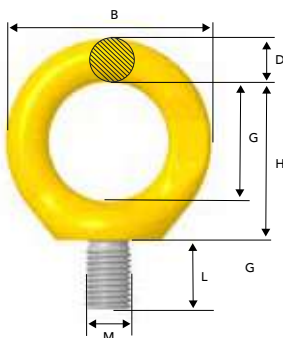

Eye lifting point ELP

Art. no.	Code	WLL tonnes*	B	D	G	H	L	M	Weight kg
Z100434	ELP-16-8	1.0**	72	16	42	55	24	M16	0.4
Z100435	ELP-20-8	1.5**	72	16	42	58	30	M20	0.4
Z100436	ELP-24-8	2.0**	88	19	48	69	36	M24	0.9
Z100437	ELP-30-8	3.0**	106	22	60	84	45	M30	1.4

** In case of 1-leg application where loading is limited to straight loading in the direction of thread (no bending force) it is possible to use ELP with four times higher WLL. Note! Threaded depths need to be at least 1xM for steel, 1,25xM for cast iron and 2xM for aluminum alloy.
Working Load Limits on page 3:13.

Spare parts

Standard length bolt and long bolt for RLP and DLP are available as spare parts.

RDRLP Metric

Standard length bolt incl. locking ring

Art. no.	Code
Z1017081	RDRLP-M8x1,25
Z1017101	RDRLP-M10x1,5
Z1017121	RDRLP-M12x1,75
Z1017161	RDRLP-M16x2
Z1017201	RDRLP-M20x2,5
Z1017241	RDRLP-M24x3
Z1017301	RDRLP-M30x3,5
Z1017361	RDRLP-M36x4
Z1017421	RDRLP-M42x4,5
Z1017481	RDRLP-M48x5



RDRLP Metric

Long bolt incl. nut, locking ring and washer

Art. no.	Code
Z10170801L	RDRLP-M8x1.25 LB
Z10171001L	RDRLP-M10x1.5 LB
Z10171201L	RDRLP-M12x1.75 LB
Z10171601L	RDRLP-M16x2 LB
Z10172001L	RDRLP-M20x2.5 LB
Z10172401L	RDRLP-M24x3 LB
Z10173001L	RDRLP-M30x3.5 LB
Z10173601L	RDRLP-M36x4 LB
Z10174201L	RDRLP-M42x4.5 LB
Z10174801L	RDRLP-M48x5 LB



3

RDRLP UNC

Standard length bolt incl. locking ring

Art. no.	Code
Z1018081	RDRLP-UNC 5/16"-18
Z1018101	RDRLP-UNC 3/8"-16
Z1018121	RDRLP-UNC 1/2"-13
Z1018161	RDRLP-UNC 5/8"-11
Z1018201	RDRLP-UNC 3/4"-10
Z1018211	RDRLP-UNC 7/8"-9
Z1018241	RDRLP-UNC 1"-8
Z1018301	RDRLP-UNC 1 1/4"-7
Z1018361	RDRLP-UNC 1 1/2"-6
Z1018421	RDRLP-UNC 1 3/4"-5
Z1018481	RDRLP-UNC 2"-4.5



RDRLP UNC

Long bolt incl. nut, locking ring and washer

Art. no.	Code
Z10180801L	RDRLP-UNC 5/16"-18 LB
Z10181001L	RDRLP-UNC 3/8"-16 LB
Z10181201L	RDRLP-UNC 1/2"-13 LB
Z10181601L	RDRLP-UNC 5/8"-11 LB
Z10182001L	RDRLP-UNC 3/4"-10 LB
Z10182101L	RDRLP-UNC 7/8"-9 LB
Z10182401L	RDRLP-UNC 1"-8 LB
Z10183001L	RDRLP-UNC 1 1/4"-7 LB
Z10183601L	RDRLP-UNC 1 1/2"-6 LB
Z10184201L	RDRLP-UNC 1 3/4"-5 LB
Z10184801L	RDRLP-UNC 2"-4.5 LB



RDDL P Metric

Standard length bolt incl. locking ring

Art. no.	Code
Z1022081	RDDL P-M8x1.25
Z1022101	RDDL P-M10x1.5
Z1022121	RDDL P-M12x1.75
Z1022161	RDDL P-M16x2
Z1022201	RDDL P-M20x2.5
Z1022241	RDDL P-M24x3
Z1022301	RDDL P-M30x3.5
Z1022361	RDDL P-M36x4
Z1022421	RDDL P-M42x4.5
Z1022481	RDDL P-M48x5



RDDL P Metric

Long bolt incl. nut, locking ring and washer

Art. no.	Code
Z10220801L	RDDL P M8x1.25 LB
Z10221001L	RDDL P M10x1.5 LB
Z10221201L	RDDL P M12x1.75 LB
Z10221601L	RDDL P M16x2 LB
Z10222001L	RDDL P M20x2.5 LB
Z10222401L	RDDL P M24x3 LB
Z10223001L	RDDL P M30x3.5 LB
Z10223601L	RDDL P M36x4 LB
Z10224201L	RDDL P M42x4.5 LB
Z10224801L	RDDL P M48x5 LB



RDDL - UNC

Standard length bolt incl. locking ring

Art. no.	Code
Z1023081	RDDL UNC 5/16"-18
Z1023101	RDDL UNC 3/8"-16
Z1023121	RDDL UNC 1/2"-13
Z1023161	RDDL -UNC 5/8"-11
Z1023201	RDDL -UNC 3/4"-10
Z1023211	RDDL -UNC 7/8"-9
Z1023241	RDDL -UNC 1"-8
Z1023301	RDDL -UNC 1 1/4"-7
Z1023361	RDDL UNC 1 1/2"-6
Z1023421	RDDL -UNC 1 3/4"-5
Z1023481	RDDL -UNC 2"-4.5



RDDL - UNC

Long bolt incl. nut, locking ring and washer

Art. no.	Code
Z10230801L	RDDL UNC 5/16"-18 LB
Z10231001L	RDDL UNC 3/8"-16 LB
Z10231201L	RDDL UNC 1/2"-13 LB
Z10231601L	RDDL UNC 5/8"-11 LB
Z10232001L	RDDL UNC 3/4"-10 LB
Z10232101L	RDDL UNC 7/8"-9 LB
Z10232401L	RDDL UNC 1"-8 LB
Z10233001L	RDDL UNC 1 1/4"-7 LB
Z10233601L	RDDL UNC 1 1/2"-6 LB
Z10234201L	RDDL UNC 1 3/4"-5 LB
Z10234801L	RDDL UNC 2"-4.5 LB



Technical information

The following information aims to give advice and explain the most common questions in order to ensure safe and proper use of lifting points. Always refer to the user instructions of the specific model of lifting point before use. It is of the most importance that this information is known to the user and in accordance with the Machinery Directive 2006/42/EC this information must be delivered to the customer.

General advice

Reference should be made to relevant standards and other statutory regulations. Inspections must be carried out only by people who possess sufficient knowledge.

Before installation and before every use, visually inspect the lifting points, paying particular attention to any evidence of corrosion, wear, weld cracks or deformations. Please ensure compatibility of bolt thread and tapped hole.

The material construction, to which the lifting point will be attached, should be of adequate strength to withstand forces during lifting without deformation.

Ensure minimum thread depth, see table (d refers to bolt diameter).

RLP, RELP, BLP, DLP

Thread depth	Yield limit of base material
1 x d	For steel, yield limit >200 MPa
1,25 x d	For cast iron, yield limit >200MPa
2,5 x d	Aluminum
	For other metal alloys or base materials consult your Gunnebo Industries distributor.

- If the bolt length needs to be adjusted the bolt should be cut in al cold saw or lathe and temperature kept as low as possible during cutting. After cutting check the shape of the threads nearest the cut with an appropriately sized die (there must not be any burrs).
- The surface facing around the thread hole shall be flat (plane), clear of dirt and smooth to ensure perfect contact with the shoulder surface of the Lifting Point.

Nut and washer

The nut and washer must be the original equipment supplied from Gunnebo Industries to ensure the correct mechanical properties. No warranty, insurance or liability will be accepted if bolts not supplied by Gunnebo Industries have been used.

Extreme environments

The in-service temperature affects the WLL as follows:

RLP

Temperature (°C)	Reduction of WLL
-40 to +200 °C	0 %
+200 to +300 °C	10 %
+300 to +400 °C	25 %
Temperatures below -40°C or above 400 °C are not allowed.	

RELP

Temperature (°C)	Reduction of WLL
-40 to +100 °C	0 %
+100 to +200 °C	15 %
+200 to +250 °C	20%
+250 to +350 °C	25 %
Temperatures above 350 °C are not allowed.	

BLP / DLP

Temperature (°C)	Reduction of WLL
-40 to +200 °C	0 %
Temperatures below -40° C or above 200° C are not allowed.	

Severe environments

Lifting points must not be used in alkaline (> pH10) or in acidic condition (< pH6). Comprehensive and regular examination must be carried out when used in severe or corrosive environments. In uncertain situations consult your Gunnebo Industries distributor.

Surface treatment

- Hot dip galvanizing or plating is not allowed outside the control of the manufacturer.
- Acid or Alkaline cleaning is not allowed.

Protect yourself and others

- Before each use the Lifting Point should be checked for obvious damage or deterioration.
- Know the weight of the load and its center of gravity.
- Ensure the load is ready to move and that no obstacles will obstruct the lifting.
- Check the conformity of the load with the Working Load Limit.
- Prepare the landing site.
- Never overload and avoid shock loading.
- Never use an improper configuration.
- Never use a worn or damaged Lifting Point.
- Do not ever ride on the load.
- Do not ever walk or stand under a suspended load.
- Take into consideration that the load may swing or rotate.
- Watch your feet and fingers while loading/unloading.

Inspection

Periodic thorough examination must be carried out at least every 12 months or more frequently according to local statutory regulations, type of use and past experience.

- Ensure correct bolt and nut size, quality and length.
- Ensure compatibility of bolt thread and tapped hole – control of the torque.
- The lifting point should be complete.
- The working load limit and manufacturers stamp should be clearly visible.
- Check for deformation of the component parts such as body, load ring and bolt.
- Check for mechanical damage, such as notches, particularly in high stress areas.
- Wear should be no more than 10 % of cross sectional diameter.
- Evidence of corrosion.
- Evidence of cracks.
- Damage to the bolt, nut and/or thread.
- The body of the lifting point must be free to rotate.

Symmetric loading conditions

- For three and four leg lifts, the lifting points should be arranged symmetrically around the center of gravity and in the same plane if possible.
- The WLL for Gunnebo Industries lifting points is based on symmetrical loading.
- The lifting point must be positioned on the load in such way that movement is avoided during lifting.
- For single leg lifts, the lifting point should be vertically above the center of gravity of the load.
- For two leg lifts, the lifting points must be equidistant to or above the center of gravity of the load.

Asymmetric loading conditions

- For unequally loaded lifts we recommend that the WLL is determined as follows:
- 2-leg slings are calculated as the corresponding 1-leg sling.
- 3 and 4-leg slings are calculated as the as the corresponding 1-leg sling*

* (If 2-legs with full certainty are carrying the major part of the load, the WLL can be calculated as for the corresponding 2-leg sling).

WLP - Welding

Preheat the structure if the temperature is below 0°C; otherwise follow AS 1554 or other suitable national standard.

- Ensure that the WLP cannot move during welding by welding the corners of the welding block.
- Continue the weld around the welding block without interruption in a single operation.
- The nozzle or electrode should be at 45° (see Fig. C), so that the required penetration is obtained. The minimum throat (A) should be maintained.

Product	Min. plate gauge (Rm-1250 N/mm ²) t _{min} (mm)	Min. throat thickness (mm)
WLP 2.5 T	11	11
WLP 4 T	19	13
WLP 7 T	24	16
WLP 10 T	30	18
WLP 16 T	40	20

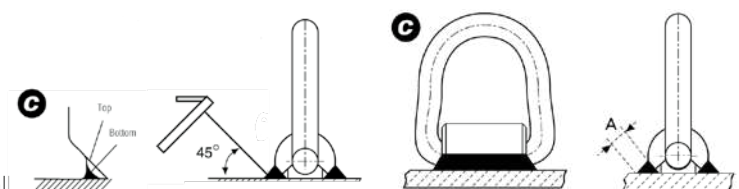

- The weld should not contain cracks or pores.
- Do not cool the weld with water. It should be left cool natural

Working Load Limits* WLP

		1-leg	2-leg		3- and 4-leg	
Typ	WLL tonnes*		α 0-90° β 0-45°	α 90-120° β 45-60°	α 0-90° β 0-45°	α 90-120° β 45-60°
WLP-2.5T	2.5		3.5	2.5	5.2	3.7
WLP-4T	4.0		5.6	4.0	8.4	6.0
WLP-7T	7.0		9.8	7.0	14.8	10.5
WLP-10T	10.0		14.1	10.0	21.2	15.0
WLP-16T	16.0		22.5	16.0	33.6	24.0

Working Load Limits* SLP

		1-leg	2-leg		3- and 4-leg	
Typ	WLL tonnes*		α 0-90° β 0-45°	α 90-120° β 45-60°	α 0-90° β 0-45°	α 90-120° β 45-60°
SLP-1T	1.0		1.4	1.0	2.1	1.5
SLP-3T	3.0		4.2	3.0	6.3	4.5
SLP-5T	5.0		7.0	5.0	10.6	7.5

Working Load Limits* ELP

		1-leg	2-leg		3- and 4-leg	
Typ	WLL tonnes*		α 0-90° β 0-45°	α 90-120° β 45-60°	α 0-90° β 0-45°	α 90-120° β 45-60°
ELP-16-8	1.0**		1.4	1.0	2.1	1.5
ELP-20-8	1.5**		2.1	1.5	3.1	2.3
ELP-24-8	2.0**		2.8	2.0	4.2	3.0
ELP-30-8	3.0**		4.2	3.0	6.3	4.5

Note! The above loads apply to normal usage and equally loaded legs. For asymmetric loaded chain slings, the following is recommended:

- A two-legged system is rated as a single-legged system.
- A three- or four-legged system is rated as a two-legged system.

** In case of 1-leg application where loading is limited to straight loading in the direction of thread (no bending force) it is possible to use ELP with four times higher WLL. Note! Threaded depths need to be at least 1xM for steel, 1,25xM for cast iron and 2xM for aluminum alloy.

Shackles & Rigging Screws

- Dee and Bow
- Arctic
- Aquaculture
- ROV
- Stainless Steel



GUNNEBO
Industries

Shackles

About Gunnebo Industries Shackles	4:2
Dee and Bow Shackles	4:3 - 4:4
Arctic Shackles	4:5
Super Shackles	4:6
Aquaculture	4:7
Mooring Shackle	4:8
Countersunk Shackle	4:8
Mooring Bolts	4:9
Galvanized Master Link	4:9
ROV Shackles	4:10 - 4:11
Stainless Steel Shackles	4:12 - 4:13
Shackle SA	4:13

Rigging Screws

Rigging Screws, Alloy Steel	4:14
Rigging Screws, Hot Dip Galvanized	4:14

Technical Information, Shackles

Instructions for safe use	4:15
---------------------------	------

Feel confident in every situation

Our lifting systems are valued for their long durability and high quality. Whether the working environment is hot or cold, our systems assure lifting operations with high safety and functionality.

Gunnebo Industries shackles are made from a range of steel qualities, including acid proof stainless steel and high grade alloy steel to comply with the most stringent specifications. Our workshops comprise all facilities and systems for the manufacturing and control of a top quality product. This includes tool design, an advanced tool shop, forging, heat treatment, machining, hot dip galvanizing and quality control.

We offer a range of DNV 2.7-1 Type approved lifting shackles for offshore containers, developed for the tough conditions of the offshore industry, where safety must be of the highest priority at all times. The heat treatment of these products ensures the proper ductility and strength to sustain shock loads which may be imposed when the container is lifted from the deck of a vessel.

Furthermore we offer Standard shackles, Super lifting shackles with increased working load limit, ROV shackles, Heavy duty shackles, Wide-Body shackles, Mooring shackles, Stainless Steel shackles etc.

Make sure you have the original

- High quality shackles according to EN 13889 and U.S. Fed.Spec RR-C. 271 (grade A and grade B)
- Consistent product quality
- Long experience of shackle production using modern manufacturing methods
- Local availability of expertise from Gunnebo Industries subsidiary or distributors

To ensure you have a genuine Gunnebo Industries Shackle, it should be marked as below:



Dee Shackle No 834

Standard: EN 13889 and U.S Fed. Spec. RR-C-271
 Material: High Tensile Carbon Steel, Quenched and tempered, Grade 6
 Finish: All parts hot dip galvanized, pin brown painted on top of galv.
 Safety factor: 6:1
 Documentation: Test certificate and traceable raw material /inspection certificate according to EN 10204 - 3.1
 Temperature: -20°C to 200°C



Art. no. Screw pin	WLL tonnes 6:1	Dim. d1	d Trade size		Inner width a*	Inner length c*	Eye outer d2	Screw pin kg
			mm	inch				
A083416	3.25	19	16	5/8"	27	51	40	0.55
A083419	4.75	22	19	3/4"	31	60	48	1.00
A083422	6.5	25	22	7/8"	37	71	52	1.30
A083425	8.5	28	25	1"	43	81	60	1.90
A083428	9.5	32	28	1 1/8"	46	90	64	2.80
A083432	12.0	35	32	1 1/4"	52	100	72	3.60
A083435	13.5	38	35	1 3/8"	57	111	76	4.60
A083438	17.0	42	38	1 1/2"	60	122	84	6.50
A083445	25.0	50	45	1 3/4"	74	149	105	11.50

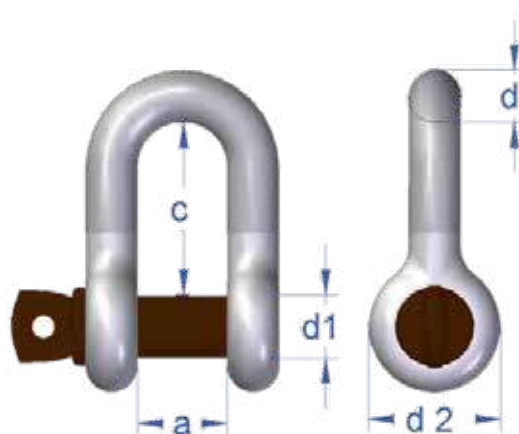

Shackle No 834 with screw pin

* Forging tolerance: +/- 5% on inside width/length.

Dee Shackle No 835

Standard: DNV 2.7-1 Type Approved, EN 13889 and U.S Fed. Spec. RR-C-271
 Material: High Tensile Carbon Steel, Quenched and tempered, Grade 6
 Finish: All parts hot dip galvanized, pin brown painted on top of galv.
 Safety factor: 6:1
 Documentation: Test certificate and traceable raw material / inspection certificate according to EN 10204 - 3.1. DNV 2.7-1 and DNV 2.7-3 Type Approval Certification.
 Temperature: -20°C to 200°C



Art. no. Safety bolt	WLL tonnes 6:1	Dim. d1	d Trade size		Inner width a*	Inner length c*	Eye outer d2	Safety bolt kg
			mm	inch				
A083516	3.25	19	16	5/8"	27	51	40	0.60
A083519	4.75	22	19	3/4"	31	60	48	1.10
A083522	6.5	25	22	7/8"	37	71	52	1.50
A083525	8.5	28	25	1"	43	81	60	2.20
A083528	9.5	32	28	1 1/8"	46	90	64	3.10
A083532	12.0	35	32	1 1/4"	52	100	72	4.20
A083535	13.5	38	35	1 3/8"	57	111	76	5.60
A083538	17.0	42	38	1 1/2"	60	122	84	7.50
A083545	25.0	50	45	1 3/4"	74	149	105	13.00

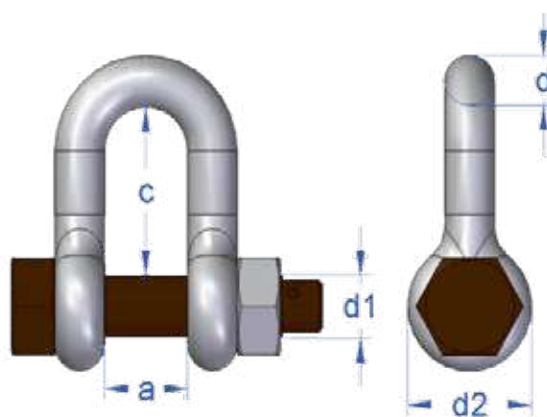

Shackle No 835 with safety bolt

* Forging tolerance: +/- 5% on inside width/length. Split pin included

Bow Shackle No 854

Standard: EN 13889 and U.S Fed. Spec. RR- C-271
 Material: High Tensile Carbon Steel, Quenched and tempered, Grade 6
 Finish: All parts hot dip galvanized, brown painted bolts on top of galv.
 Safety factor: 6:1
 Documentation: Test certificate and traceable raw material / inspection certificate according to EN-10204 - 3.1.
 Temperature: -20°C to 200°C

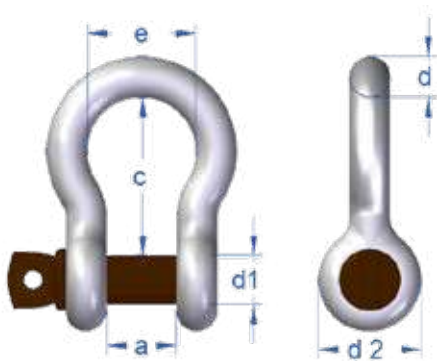

Shackle No 854 with screw pin

Art. no. Screw pin	WLL tonnes 6:1	Dim. d1	d Trade size		inner width a*	inner length c*	Bow width e	Eye outer d2	Screw pin kg
			mm	inch					
A085413	2.0	16	13	1/2"	21	47	33	33	0.37
A085416	3.25	19	16	5/8"	27	60	42	40	0.65
A085419	4.75	22	19	3/4"	31	71	49	48	1.10
A085422	6.5	25	22	7/8"	37	84	60	52	1.50
A085425	8.5	28	25	1"	43	95	68	60	2.21
A085428	9.5	32	28	1 1/8"	46	108	74	64	3.10
A085432	12.0	35	32	1 1/4"	52	119	83	72	4.20
A085435	13.5	38	35	1 3/8"	57	132	89	76	6.00
A085438	17.0	42	38	1 1/2"	60	146	98	84	8.00
A085445	25.0	50	45	1 3/4"	74	178	127	105	13.50
A085452	35.0	57	50	2"	83	197	138	112	19.00
A085464	55.0	70	65	2 1/2"	105	260	180	145	38.00

* Forging tolerance: +/- 5% on inside width/length.

Bow Shackle No 855

Standard: DNV 2.7-1 Type Approved, EN 13889 and U.S Fed. Spec. RR-C-271
 Material: High Tensile Carbon Steel, Quenched and tempered, Grade 6
 Finish: All parts hot dip galvanized, brown painted bolts on top of galv.
 Safety factor: 6:1
 Documentation: Test certificate and traceable raw material/inspection certificate according to EN-10204 -3.1. DNV 2.7-1 and DNV 2.7-3 Type Approval
 Temperature: -20°C to 200°C

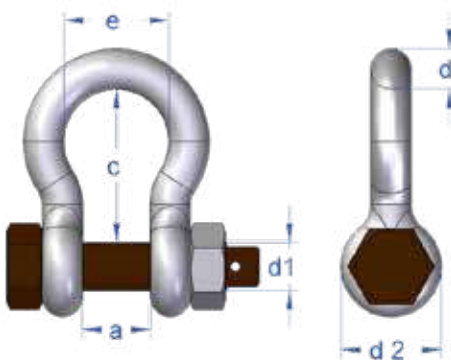

Shackle No 855 with safety bolt

Art. no. Safety bolt	WLL tonnes 6:1	Dim. d1	d Trade size		inner width a*	inner length c*	Bow width e	Eye outer d2	Safety bolt kg
			mm	inch					
A085513	2.0	16	13	1/2"	21	47	33	33	0.42
A085516	3.25	19	16	5/8"	27	60	42	40	0.70
A085519	4.75	22	19	3/4"	31	71	49	48	1.20
A085522	6.5	25	22	7/8"	37	84	60	52	1.70
A085525	8.5	28	25	1"	43	95	68	60	2.58
A085528	9.5	32	28	1 1/8"	46	108	74	64	3.40
A085532	12.0	35	32	1 1/4"	52	119	83	72	4.80
A085535	13.5	38	35	1 3/8"	57	132	89	76	7.00
A085538	17.0	42	38	1 1/2"	60	146	98	84	9.00
A085545	25.0	50	45	1 3/4"	74	178	127	105	15.00
A085552	35.0	57	50	2"	83	197	138	112	21.00
A085564	55.0	70	65	2 1/2"	105	260	180	145	39.00

* Forging tolerance: +/- 5% on inside width/length.

Split pin included

Arctic Shackle No 856

Bow shackle with safety bolt

Unique benefits with the Arctic Shackle

Adverse weather and rough sea conditions in combination with extremely low temperatures, as often encountered for instance in the North Sea, places tough requirements on the products used. Gunnebo Industries has a range of shackles specially designed for these conditions. The Arctic Shackle is type approved to DNV 2.7-1 Offshore containers and meets the impact requirements of 42 J at - 40 degrees °C.

The Arctic Shackle is a grade 8 shackle with all parts hot dipped galvanized, including the safety bolt, and has the characteristic brown color marking.



Standard:	DNV 2.7-1, U.S. Fed. Spec. RR.C-271 and EN-13889
Material:	Special Alloy Steel, Quenched and Tempered, Grade 8
Finish:	All parts hot dip galvanized + brown color marking
Safety factor:	As specified in the table below
Documentation:	Test certificate and traceable raw material / inspection certificate according to EN 10204 - 3.1 DNV 2.7-1 and DNV 2.7-3 Type Approval Certification.
Temperature:	- 40 °C to 200 °C

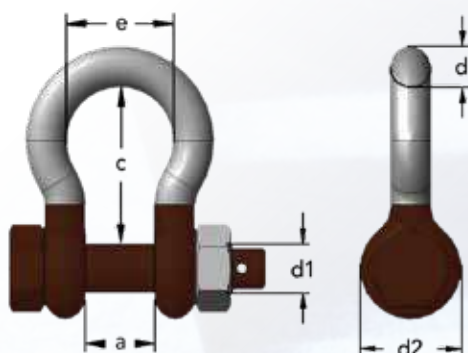

Art. no.	WLL tonnes	Dim. d1	d Trade size		a	c	d 2	e	Weight kg	Safety factor
			mm	inch						
A085613	2.0	16	13	1/2"	21	47	33	33	0.42	8.00
A085616	3.25	19	16	5/8"	27	60	40	42	0.7	8.00
A085619	4.75	22	19	3/4"	31	71	48	49	1.2	8.00
A085622	6.5	25	22	7/8"	37	84	52	60	1.7	7.85
A085625	8.5	28	25	1"	43	95	60	68	2.5	7.25
A085628	9.5	32	28	1 1/8"	46	108	64	74	3.4	6.94
A085632	12.0	35	32	1 1/4"	52	119	72	83	4.8	6.40
A085635	13.5	38	35	1 3/8"	57	132	76	89	7	6.10
A085638	17.0	42	38	1 1/2"	60	146	84	98	9	6.00
A085645	25.0	50	45	1 3/4"	74	178	105	127	15	6.00
A085652	35.0	57	50	2"	83	197	116	138	21	6.00
A085664	55.0	70	65	2 1/2"	105	260	145	180	39	6.00

Split pin included

Super Shackle No 858

Bow shackle with safety bolt

Unique benefits with the Super Shackle

In certain situations, a demand for extra Working Load Limit occurs, in others the lifting environment has limited space for the lifting application. Gunnebo Industries has therefore added the Super Shackle to the range, enabling the same Working Load Limit on a 22 mm Super shackle as for a 28 mm Standard shackle.

The Super shackle meets the US Federal Specification RR.C-271. It is a grade 8 shackle and has all parts hot dipped galvanized, including the safety bolt.



- Standard: U.S. Fed. Spec. RR.C-271 Type IVA Class 3, Grade B
- Material: High Tensile Steel. Quenched and Tempered, Grade 8
- Finish: All parts hot dip galvanized + brown color marking
- Safety factor: 5:1
- Documentation: Test certificate and traceable 3.1 certificate
- Temperature: -20 °C to 200 °C

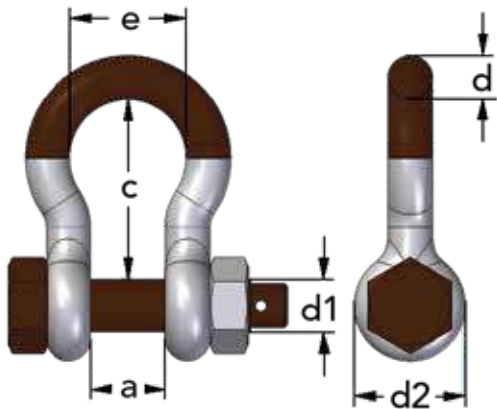

Art.no	WLL tonnes	Dim. d1	d Trade size		a	c	d2	e	Weight kg
			mm	inch					
A085813	3.3	16	13	1/2"	21	51	33	33	0.4
A085816	5.0	19	16	5/8"	27	60	40	42	0.7
A085819	7.0	22	19	3/4"	31	71	48	49	1.2
A085822	9.5	25	22	7/8"	37	84	52	60	1.7
A085825	12.5	28	25	1"	43	95	60	68	2.5
A085828	15.0	32	28	1 1/8"	46	108	64	74	3.4
A085832	18.0	35	32	1 1/4"	52	119	72	83	4.8
A085835	21.0	38	35	1 3/8"	57	132	76	89	7
A085838	30.0	42	38	1 1/2"	60	146	84	98	8.8
A085845	40.0	50	45	1 3/4"	74	178	105	127	15

Split pin included

Aquaculture

Because safety is everything

Gunnebo Industries have an in-depth knowledge of the demands aquaculture puts on the products supplied. With over 100 years of experience gained manufacturing shackles and chain for maritime use, which allows us to provide our clients with the highest level of satisfaction, even in the most extreme environments.

Whilst other producers have been focusing on low cost to the detriment of performance, we have focused on quality and improved properties to give best value for money. Products such as our hot dip galvanized chain and shackles are designed to satisfy the specific demands from the global fishing industry.

Gunnebo Industries products are the best choice when safety and quality comes first. We have always and will continue to provide the Aquaculture industry with the preferred products available on the market. All of our aquaculture products are independently approved according to Norwegian standard NS 9415. NS 9415 with this being the first national standard for aquaculture mooring systems.

Our continuous focus on quality has been proven by our achievements with the key industry standards:

- Approved according to ISO 9001
- Approved according to ISO 14001
- Product certification according to NS 9415

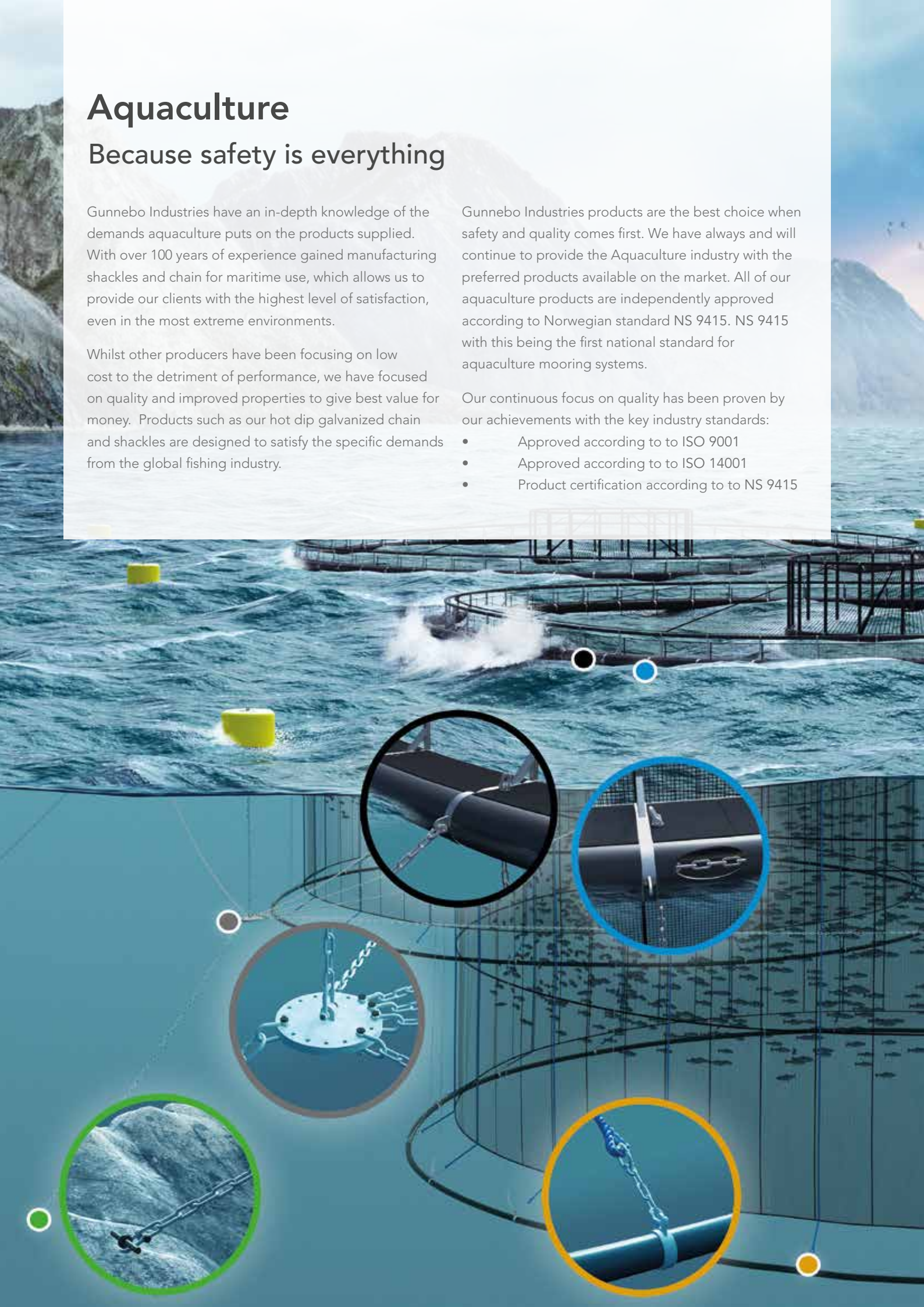

Mooring Shackle No 852

Unique benefits with Mooring Shackle

The Mooring Shackle has a sunken bolt that locks into the shackle to prevent rotation (unintentional loosening of the nut). The sunken bolt also reduces the risk of the shackle interacting with the net.

Fatigue resistance is increased by the addition of 25% extra material in the bow (increased life span and safety).

The shackle has a spacious bow for connecting thimbles, rope and mooring/connecting plates.

Standard: Third party approved according to relevant Norwegian aquaculture standards

Material: High Tensile Steel. Quenched and Tempered, Grade 6

Finish: All parts hot dip galvanized + brown color marking

Plastic clip provided as standard safety pin for 28T - 90T, stainless steel A4 split pins provided as standard for 110T and 150T.

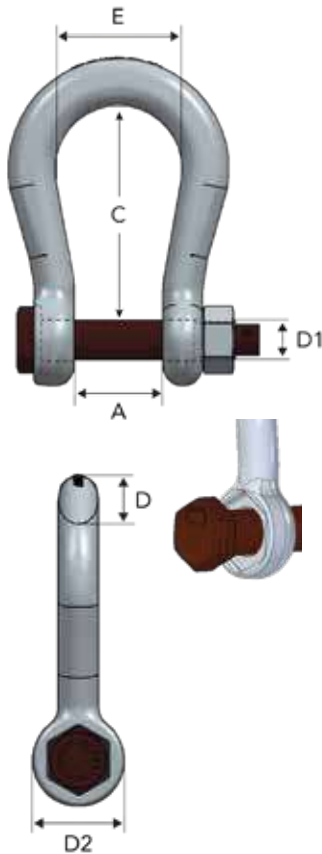

Art.no	MBL tonnes	D Trade size		A	C	E	D2	D1
		mm	inch					
*A085219	28	19	3/4"	44	100	58	48	22
*A085222	40	22	7/8"	52	125	68	52	25
*A085228	60	28	1 1/8"	62	150	89	64	28
*A085232	90	32	1 1/4"	82	170	98	72	32
A085242	110	42	1 5/8"	112	200	150	90	45
A085245	150	45	1 3/4"	126	248	175	105	50

* These sizes come with a sunken hexagon bolt head that will greatly reduce the risk of the bolt unscrewing in service as well as making the fitting easier for the user.

Customized securing options

- Clips (28T to 40T) - Yellow
- Clips (60T to 90T) - Green
- Plastic covered seizing wire
- Plastic covered steel wire
- Stainless steel cotter pin

Countersunk Shackle No 830

Standard: Third party approved according to relevant Norwegian aquaculture standards

Material: High Tensile Steel. Quenched and Tempered, Grade 6

Finish: All parts hot dip galvanized + brown color marking

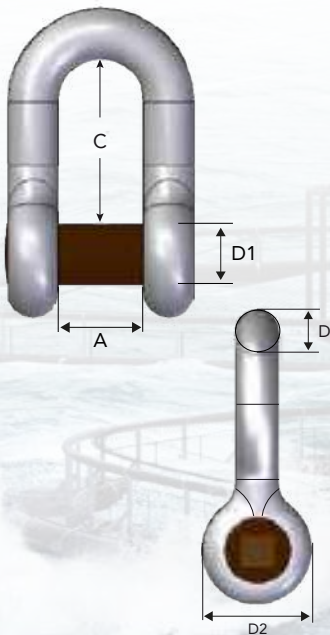

Art.no	Art.no*	WLL tonnes	Dim. D		A	C	D1	D2	Square hole	Recommending Key
			mm	inch						
A083013	A083013DP	2.0	13	1/2"	21	41	16	33	10x10	3/8"
A083016	A083016DP	3.25	16	5/8"	27	51	19	40	10x10	3/8"
A083019	A083019DP	4.75	19	3/4"	31	60	22	48	10x10	3/8"
A083022	A083022DP	6.5	22	7/8"	37	71	25	52	14x14	1/2"
A083025	A083025DP	8.5	25	1"	43	81	28	60	14x14	1/2"

* Countersunk Shackles can also be supplied with a secondary securing for Double Protection (DP), for mooring applications.

Long link Chain LLZ - see chapter 5

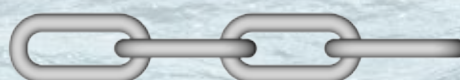

Mooring bolt - Eye Bolt No 8250

Standard: Third party approved according to relevant Norwegian aquaculture standards

Material: High Tensile Steel. Quenched and Tempered, Grade 6

Finish: All parts hot dip galvanized + brown color marking

Art.no	MBL tonnes	Dim Ø x L	G	E
A825032	40	Ø32 x 400	72	37
A825038	60	Ø38 x 500	84	44
A825045	80	Ø45 x 600	105	47

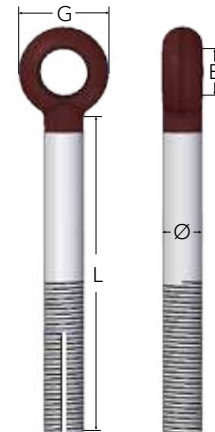

Mooring bolt - T-bolt No 8252

Standard: Third party approved according to relevant Norwegian aquaculture standards

Material: High Tensile Steel. Quenched and Tempered, Grade 6

Finish: All parts hot dip galvanized + brown color marking

Art.no	MBL tonnes	Dim Ø x L	G	E	T
A825232	40	Ø32 x 400	72	35	300
A825238	60	Ø38 x 500	84	42	350
A825445	80	Ø45x500	105	45	400
A825245	80	Ø45 x 600	105	45	400
A825450	100	Ø50x500	100	45	400
A825250	100	Ø50 x 700	110	45	400
A825265	170	Ø65 x 800	140	58	400

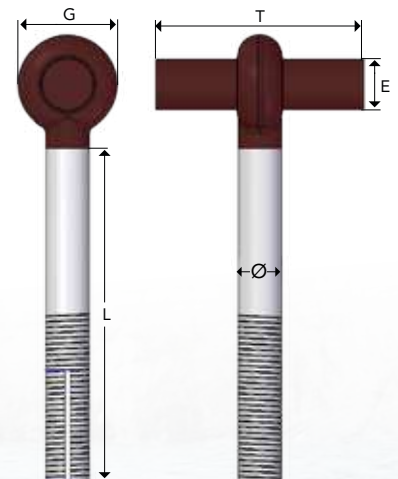

4

Galvanized Master Link

Standard: Third party approved according to relevant Norwegian aquaculture standards

Material: High Tensile Steel. Quenched and Tempered, Grade 7

Finish: All parts hot dip galvanized

Art.no	MBL tonnes	Dim Ø - D	B	L
A825922	40	Ø22	95	160
A825928	60	Ø28	110	190
A825934	80	Ø34	140	240
A825940	110	Ø40	150	250

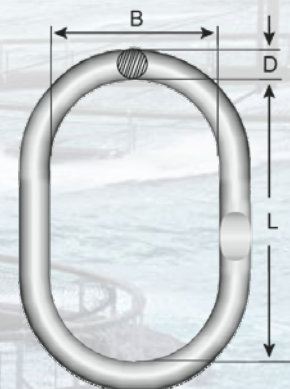

ROV Shackles

The ROV Retrieve Shackle is designed for smooth and easy use in retrieving and releasing subsea lifting and rigging operations. It has no loose parts, in closed or opened position, and there is therefore no need for wires or monkey fists that will risk snagging or getting in the way.

The high visibility handles are close-die forged and has double safety functions - shark tooth locking with indicator that will show if the shackle is in open or locked position as well as the spring loaded handle. The handle is the same size, regardless of size of shackle.

The ROV Retrieve Shackle no. 861 is an easy to operate shackle, saving valuable time and money.

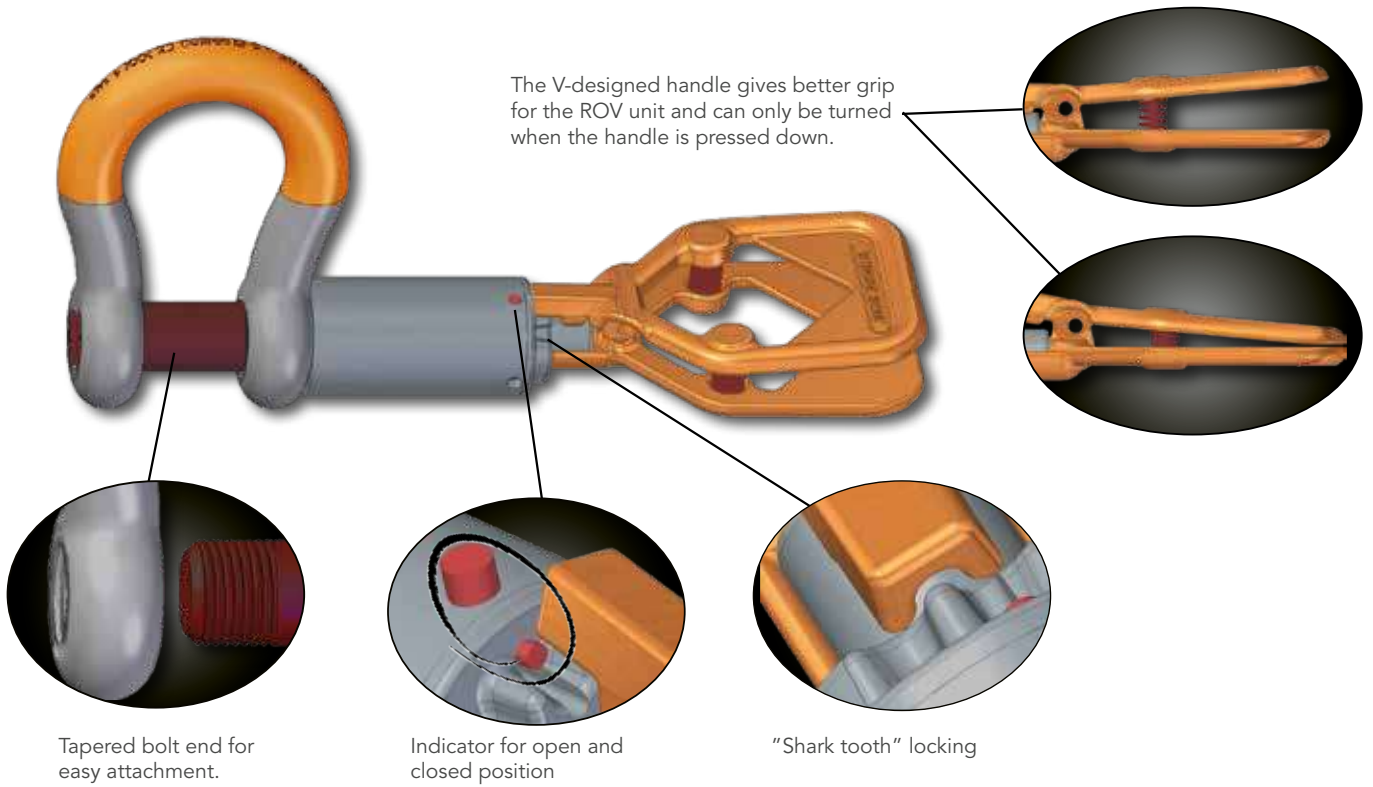

ROV Retrieve Shackle No 861

All shackles have unique marking

- Standard: Dim. according to EN 13889
- Material: High Tensile Steel, Quenched and Tempered
- Finish: All load bearing parts hot dip galvanized
- Safety factor: 6:1
- Documentation: Test certificate and traceable 3.1 certificate supplied on request.
- Temperature: -40 °C to 200 °C

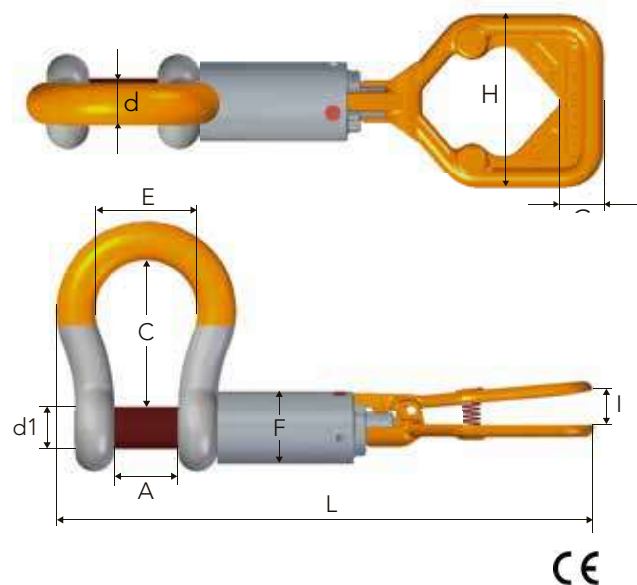

Art. no	WLL tonnes	d1	d	A	C	E	F	L	I	H	G	Weight kg
A086128	9.5	32	28	46	108	74	60	440	31	132	33	6.5
A086132	12.0	35	32	52	119	83	60	460	31	132	33	8.0
A086138	17.0	42	38	60	146	98	63.5	501	31	132	33	10.5
A086145	25.0	50	45	74	178	127	70	565	31	132	33	16.5
A086152	35.0	57	50	83	197	138	76	604	31	132	33	20.5
A086164	55.0	70	65	105	260	180	88	712	31	132	33	42.0

ROV Shackle No 860

Threaded bolt with one locking pin

Standard:	Dim. according to EN 13889
Material:	High Tensile Steel, Quenched and Tempered
Finish:	All load bearing parts hot dip galvanized
Safety factor:	6:1
Documentation:	Test certificate and traceable 3.1 certificate supplied on request.
Temperature:	-40 °C to 200 °C



Art. no.	WLL tonnes	d1	d	a	c	d2	e	Weight kg
A086028	9.5	32	28	46	108	64	68	3.4
A086032	12.0	35	32	52	119	72	83	5.0
A086038	17.0	42	38	60	146	84	98	7.8
A086045	25.0	50	45	74	178	105	127	13.9
A086052	35.0	57	50	83	197	127	138	17.0
A086064	55.0	70	65	105	260	152	180	37.0

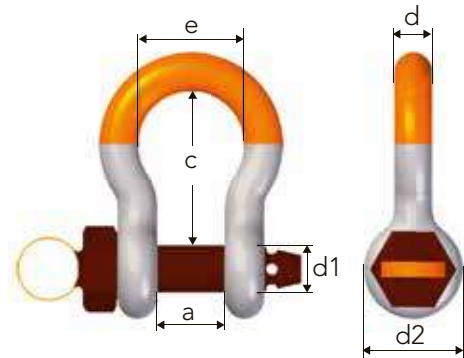

ROV Release Shackle No 863

Equipped with bolt and two locking pins

Standard:	Dim. according to EN 13889
Material:	High Tensile Steel, Quenched and Tempered
Finish:	All load bearing parts hot dip galvanized
Safety factor:	5:1
Documentation:	Test certificate and traceable 3.1 certificate supplied on request.
Temperature:	-40 °C to 200 °C



Art. no.	WLL tonnes	d1	d	a	c	d2	e	Weight kg
A086322	6.5	25	22	37	84	52	58	1.6
A086328	9.5	32	28	46	108	64	74	3.4
A086332	12.0	35	32	52	119	72	83	5.0
A086338	17.0	42	38	60	146	84	98	7.8
A086345	25.0	50	45	74	178	105	127	13.9
A086352	35.0	57	50	83	197	127	138	17.0
A086364	55.0	70	65	105	260	152	180	37.0

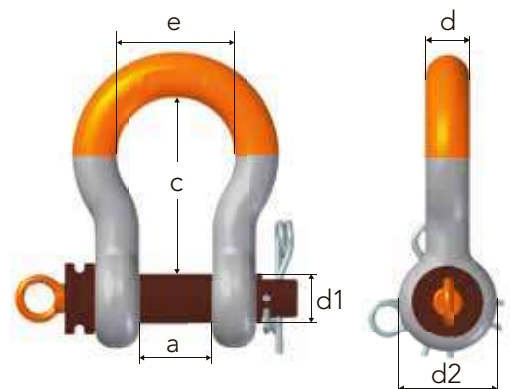

Stainless Steel Shackle No 735

Dee shackle with safety bolt

Material: AISI 316
 Finish: Highly Polished
 Safety factor: 6:1
 Documentation: Test certificate and traceable 3.1 certificate supplied on request.

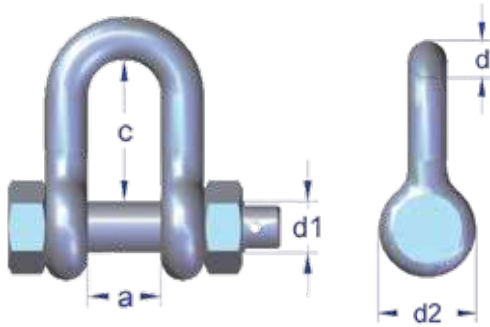

CE

Art. no.	WLL tonnes	d1	d	a	c	d2	Weight kg
A073510	0.6	10	10	20	38	20	0.2
A073512	0.9	12	12	26	50	24	0.3
A073516	1.5	16	13	24	52	33	0.4
A073520	2.5	19	16	28	65	40	0.7
A073522	3.0	22	19	31	60	48	1.5
A073524	4.5	25	22	37	71	52	1.3
A073533	7.5	32	28	46	90	64	3.0
A073536	10.0	35	32	52	100	72	4.1

Split pin included

Stainless Steel Shackle No 755

Bow shackle with safety bolt

Material: AISI 316
 Finish: Highly Polished
 Safety factor: 6:1
 Documentation: Test certificate and traceable 3.1 certificate supplied on request.

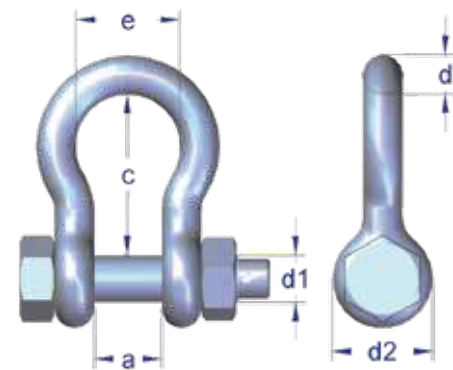

CE

Art. no.	WLL tonnes	d1	d	a	c	e	d2	Weight kg
A075510	0.6	10	10	20	36	27	20	0.2
A075512	0.9	12	12	25	47	37	26	0.3
A075516	1.5	16	13	25	47	33	34	0.4
A075520	2.5	20	16	28	60	42	40	0.8
A075522	3.0	22	19	31	71	51	48	1.3
A075524	4.5	25	22	37	84	58	52	1.7
A075533	7.5	32	28	46	108	74	64	3.4
A075536	10.0	35	32	52	119	83	72	5.2

Split pin included

Stainless Steel Shackle No 732

Dee shackle with countersunk pin

Material: AISI 316
 Finish: Highly Polished
 Safety factor: 6:1
 Documentation: Test certificate supplied on request.

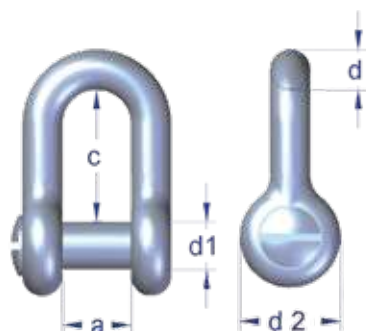

CE

Art. No.	WLL tonnes	Dim. d1 mm	d1	d	a	(c)	d2	Weight kg
A073216	2.0	M16	16	13	24	52	34	0.3
A073220	3.0	M20	20	16	28	65	40	0.6
A073222	3.0	M22	22	19	31	60	48	1.4

Stainless Steel Shackle No 730

Dee shackle with screw pin

Material: AISI 316
 Finish: Highly Polished
 Safety factor: 6:1
 Documentation: Test certificate supplied on request.



Art. no.	WLL tonnes	Dim. d1 mm	d	a	c	d2	Weight kg
A073008S	0.4	M8	8	16	30	16	0.06
A073010S	0.6	M10	10	20	38	20	0.1
A073012S	0.9	M12	12	26	50	24	0.2
A073016S	1.5	M16	13	24	52	34	0.3
A073020S	2.5	M20	16	28	65	40	0.6
A073022S	3.0	M22	19	30	72	48	0.9

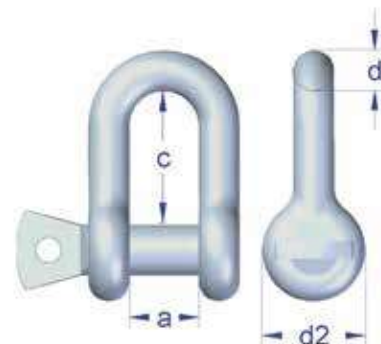

Stainless Steel Shackle No 750

Bow shackle with screw pin

Material: AISI 316
 Finish: Highly Polished
 Safety factor: 6:1
 Documentation: Test certificate supplied on request.



Art. no.	WLL tonnes	Dim. d1 mm	d1	d	a	c	e	d2	Weight kg
A075008S	0.4	M8	8.0	8	16	30	23	16	0.07
A075010S	0.6	M10	10.0	10	20	36	27	20	0.11
A075012S	0.9	M12	12.0	12	25	47	37	26	0.25
A075016S	1.5	M16	13.0	13	25	47	34	33	0.33
A075020S	2.5	M20	16.0	16	28	60	42	40	0.96
A075022S	3.0	M22	19.0	19	31	71	51	48	1.0

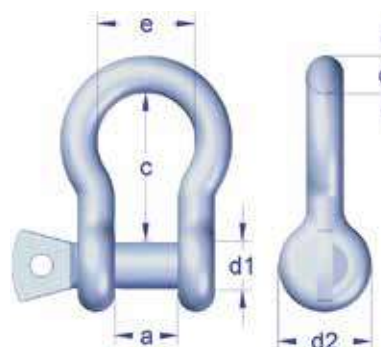

4

Shackle SA

EN 1677-1

Finish: Painted yellow
 Material: Alloy steel, Grade 8
 Safety factor: 4:1



Art. no.	Code	WLL tonnes	For chain dim. mm	c	a	d	d2	d1	Weight kg appr.
Z100706	SA-7/8-8	2.0	7, 8	30	15	8	20	M10	0.1
Z298728	SA-10-8	3.2	10	52	24	13	34	M16	0.4
Z292528	SA-13-8	5.4	13	65	28	16	40	M20	0.7
Z293024	SA-16-8	8.2	16	72	30	18	46	M22	1
Z299622	SA-19-8	11.5	19	86	36	22	52	M27	1.7
Z294122	SA-22-8	15.5	22	94	40	25	60	M30	2.5
Z304328	SA-26-8	21.7	26	116	48	32	76	M38	5.2

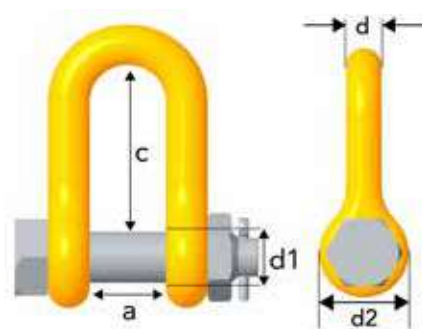

Split pin included

Alloy Steel Rigging Screw, No 801, 802, 804

Grade 6

Standard: Working load according to U.S. Fed. spec. FF-T-791.b
Supplied with closed body from 2,5-17 T, larger dimensions open body.

Material: Quenched and tempered alloy steel

Surface treatment: Hot dip galvanized

Safety factor: 5:1

Certificate: Test certificate and traceable 3.1 certificate supplied on request.

Tolerances: +/- 5%

Temperature: -20 °C to 200 °C

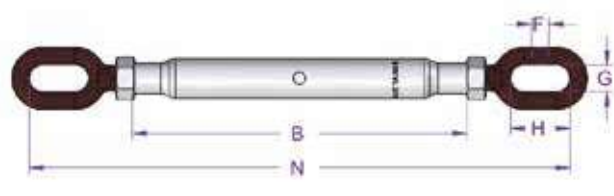
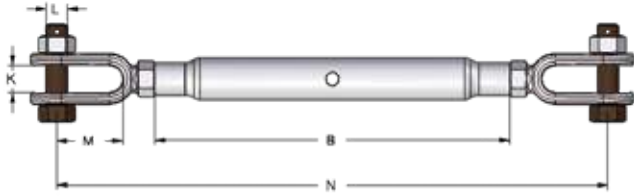

Art. no. Jaw/Jaw	Art. no. Jaw/Eye	Art. no. Eye/Eye	Thread M/UNC	WLL tonnes	Take up range mm	B	N	K	L	M	F	G	H	Weight kg/ea
A801420	A802420	A804420	M 20	2.5	210	270	455	20	16	50	13	21	45	2.3
A801424	A802424	A804424	M 24	5.0	250	340	570	28	22	65	19	28	56	4.6
A801432	A802432	A804432	1.1/4"	7.0	270	370	680	38	28	85	22	35	70	8.0
A801438	A802438	A804438	1.1/2"	10.0	300	400	790	45	32	100	25	40	78	14.0
A801445	A802445	A804445	1.3/4"	13.0	360	500	870	50	39	105	30	45	90	24.0
A801450	A802450	A804450	2"	17.0	450	600	1030	58	45	120	35	45	100	38.0
A801464			*2.1/2"	27.2	534	780	1312	75	57	142				88.0
A801470			*2.3/4"	34.0	576	780	1418	90	70	145				98.0

* Open turnbuckle body without nut and split pin

Rigging Screw No 401, 402, 404 - Hot Dip Galvanized

Design: Jaw-Jaw (jaw-eye and eye-eye on request)

Standard: According to B.S. 4429, closed body - with locking nut

Material: St. 42/St. 52, normalized

Surface treatment: Hot dip galvanized (M6 & M8 zinc plated)

Safety factor: 5:1

Note: The items marked with * below are not for lifting

Tolerances: +/-5%

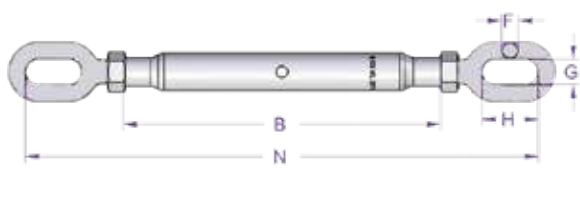
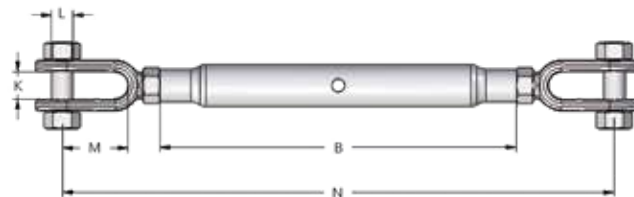

Art. no. Jaw/ Jaw	Art. no. Jaw/ Eye	Art.no Eye/Eye	Thread M/ UNC	WLL tonnes	Take up range (mm)	B	N	L	M	K	F	G	H	Weight kg/pcs
	*A402406		M 6	-	80	100	175	5	18	8	5	10	10	0.13
	*A402408		M 8	-	85	110	210	6	21	9	6	12	12	0.25
A401510	*A402410	*A404410	M 10	0.5	90	145	225	8	20	9.5	7	13	13	0.3
A401512	*A402412	*A404412	M 12	0.7	155	195	315	10	30	13	10	14	28	0.65
A401516	*A402416	*A404416	M 16	1.2	185	230	380	12	44	18	12	18	45	1.25
A401520	A402420	A404520	M 20	1.5	210	270	450	16	50	20	13	21	45	2.2
A401422	A402422	A404422	M 22	2.2	230	295	500	20	60	25	16	24	50	3.3
A401424	A402424	A404424	M 24	3.2	250	325	555	22	65	28	19	28	56	4.6
A401432	A402432	A404432	1.1/4"	4.8	290	370	680	28	85	38	22	35	70	8.5
A401438	A402438	A404438	1.1/2"	6.0	300	400	760	32	100	45	25	40	90	14.5
A401445	A402450	A404445	1.3/4"	8.5	290	400	760	38	105	50	30	45	90	20.9
A401452	A402452	A404452	2"	11.0	290	400	820	45	120	58	35	45	100	24.0

* Will not be delivered with lifting certificate.

Technical information

2006/42/EC highlights the responsibility of the manufacturer, distributor and end user of lifting gear. Gunnebo Industries shackles are specified, monitored and documented in compliance with the most stringent requirements for the product concerned. A certified ISO 9001:2008 system is an evidence of our quality standard.

Instructions for safe use

1. The user is obliged to keep a valid Test Certificate for any shackle being used in a lifting operation.
2. Before use each shackle should be inspected to ensure that:
 - all markings in the body and the pin of the shackle are legible and in compliance with the relevant Test Certificate.
 - the shackle pin is of the correct type.
 - the body and pin are not distorted or unduly worn.
 - The body and pin are free from nicks, cracks, grooves and corrosion.
 - If there is any doubt with regards to the above criteria being met, the shackle should not be used for a lifting operation.
3. It is important to ensure that the pin is safely locked after assembly. For repeated lifting between inspections of the gear, it is recommended to use a safety bolt type shackle with nut and split-pin - the user must ensure that the split-pin is fitted, to prevent the nut from unscrewing during use.
4. Incorrect seating of a pin may be due to a bent pin, damaged threads or misalignment of the holes. Do not use the shackle under these circumstances, but refer the matter to a competent person (i.e. dealer, manufacturer)
5. Shackles should be fitted to the load in a manner that allows the shackle body to take the load in a true line along its centerline to avoid undue bending stresses which will reduce the load capacity of the shackle. When using shackles in conjunction with multi-leg slings, due consideration should be given to the effect of the angle between the sling legs. When a shackle is used to secure the top block of a set of rope blocks the load on this shackle is increased by the value of the hoisting effect.
6. To avoid eccentric loading of the shackle it is recommended to distribute the load as far as possible over the total length of the pin or to use loose spacers.
7. Never modify, repair or reshape a shackle by welding, heating or bending as this will affect the nominal WLL.
8. Never heat treat a shackle as this may affect the WLL.

Reduction for side loading

Load angle	New Working Load Limit
0°	100% of original WLL
45°	70% of original WLL
90°	50% of original WLL

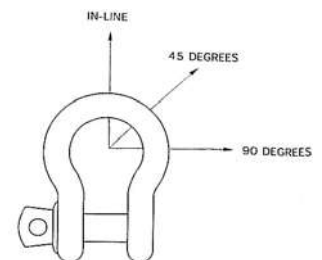

Side loads should be avoided as the products are not designed for this purpose. If side loads cannot be avoided, the following reduction factors must be taken into account:

Avoid applications where, due to load movement, the shackle pin can rotate

Shackle must be loaded in straight direction

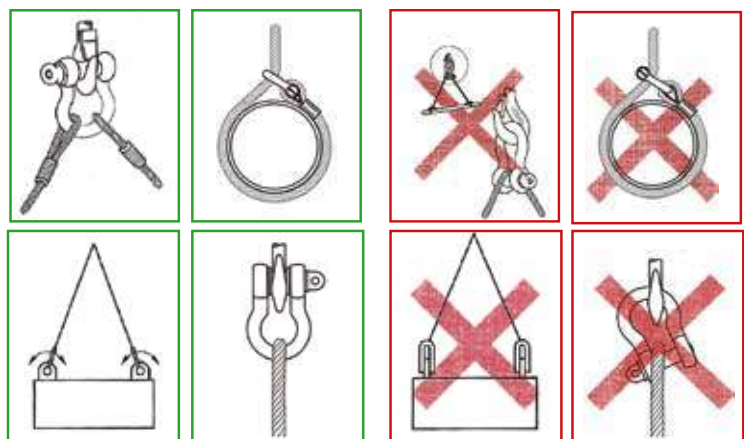

Temperature

If extreme temperature situations are applicable, the following load reductions must be taken into account.

Reduction for elevated temperatures

Temperature:	New Working Load Limit
0 - 200 °C	100% of original Working Load Limit
200 - 300 °C	90% of original Working Load Limit
300 - 400 °C	75% of original Working Load Limit
> 400 °C	not allowed

Chain

Grade 10 • Grade 8 • Short Link • Mid-link • Long-link

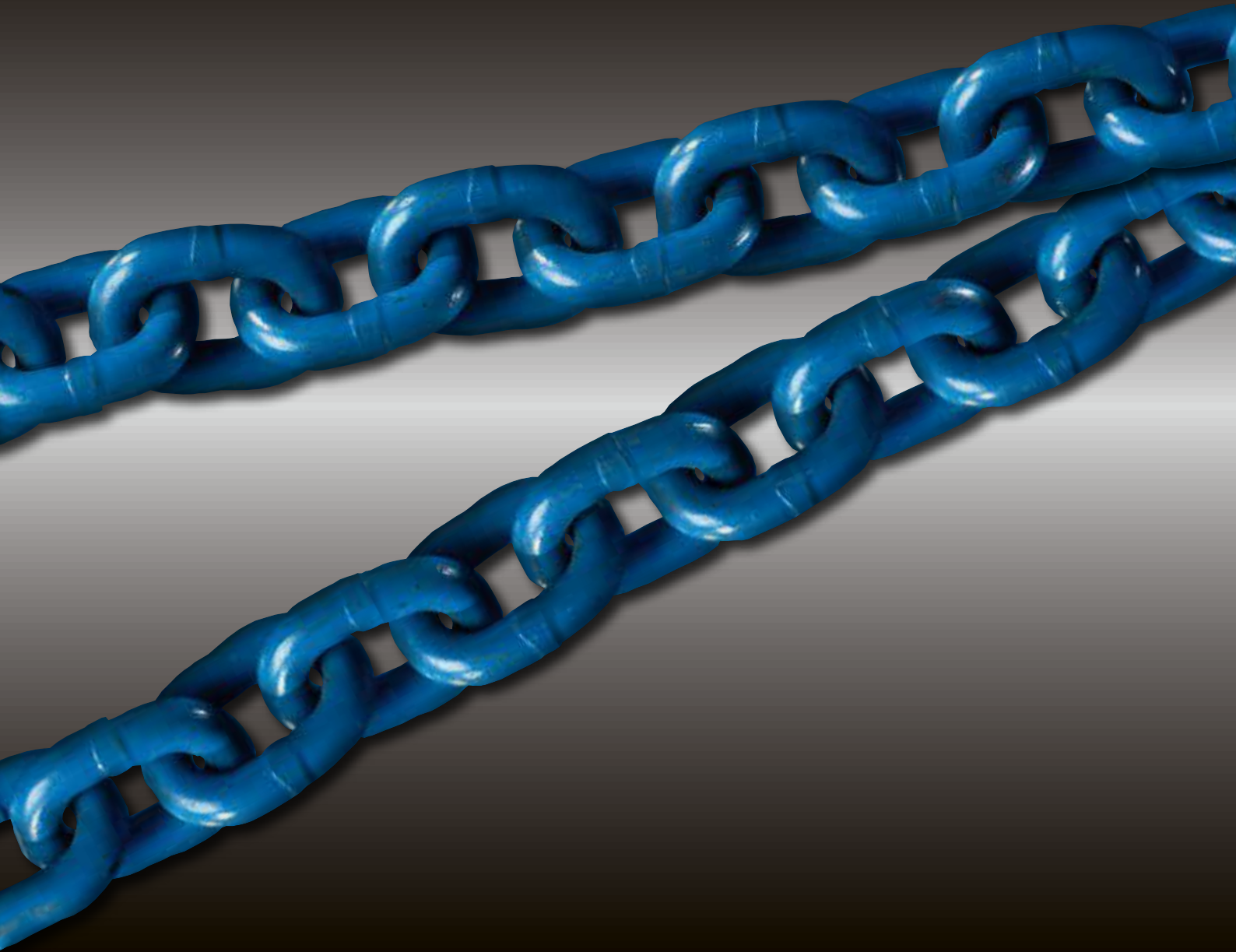

GUNNEBO
Industries

Chain

GrabiQ Chain KLA, Grade 10 (200)	5:2
GrabiQ Chain KLA, Grade 10 (400)	5:3
Classic Chain KLB/KLU, Grade 8	5:3
Galvanized Chain KLZ, Grade 8	5:3
Short Link Chain KLFU, Grade 8	5:4
Mid-link Chain MLFU, Grade 8	5:4
Long Link Chain LLU, Grade 8	5:4
Short Link Chain KLFZ, Grade 7	5:5
Mid-link Chain MLFZ, Grade 7	5:5
Long Link Chain LLZ, Grade 6	5:5

Technical Information

Chain manufacturing	5:6
Safe use and extreme environments	5:7
Definitions	5:7



GrabiQ Chain KLA, Grade 10 (200)

Short link lifting chain

Heat treatment

Hardened and tempered.

Note! For chain grade 10 (200) the maximum in service temperature is 200°C.

Surface treatment

Painted blue

Fulfills the requirements in:

ASTM A973/A973M-07(2012)

EN 818+2:2008 (WLL+25%, reduced temperature range)

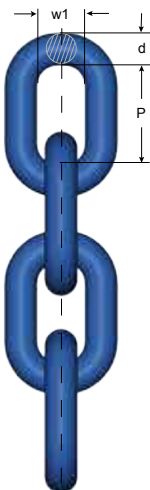

Art. no. Box	Code	WLL tonnes	d nom.	p	w1	Weight kg/m	MPF kN	Breaking force kN
Z802300 - 1 x 200 m	KLA 6-10 (200)	1.5	6	18	8.5	0.8	36.8	58.9
Z802337 - 1 x 200 m	KLA 7-10 (200)	1.95	7	21	10.0	1.1	48	77
Z802301 - 1 x 200 m	KLA 8-10 (200)	2.6	8	24	11.0	1.4	63	102
Z802302 - 1 x 100 m	KLA 10-10 (200)	4.0	10	30	14.0	2.3	98	158
Z802303 - 1 x 100 m	KLA 13-10 (200)	6.8	13	39	17.7	3.8	166	268
Z802304 - 1 x 100 m	KLA 16-10 (200)	10.3	16	48	21.9	5.6	251	402
Z802305 - 1 x 50 m	KLA 20-10 (200)	16.0	20	60	27.0	9.4	393	630
Z802246 - 1 x 50 m	KLA 22-10 (200)	20.0	22	66	29.0	11.9	491	785
Z802248 - 1 x 50 m	KLA 26-10 (200)	27.0	26	78	35.0	16.4	664	1062
Z802440 - 1 x 25 m	KLA 32-10 (200)	40.0	32	96	41.6	25.8	981	1610

GrabiQ Chain KLA, Grade 10 (400)

Short link lifting chain

Heat treatment

Hardened and tempered.

Note! For chain grade 10 (400) the maximum in service temperature is 400°C.

Surface treatment

Painted blue

Fulfills the requirements in:

EN 818-2:2008 (WLL+25%, material dimension \varnothing +10%)

Note: This chain is marked with "8+" in addition to the marking required by the machine directive

Art. no. Box	Code	WLL tonnes	d nom.	p	w1	Weight kg/m	MPF kN	Breaking force kN
Z802306 - 1 x 200 m	KLA 6-10 (400)	1.5	6.6	18	8.9	1.0	36.8	58.9
Z802307 - 1 x 200 m	KLA 8-10 (400)	2.5	8.8	24	11.2	1.7	63	102
Z802308 - 1 x 100 m	KLA 10-10 (400)	4.0	11.0	30	14.4	2.6	98	158
Z802309 - 1 x 100 m	KLA 13-10 (400)	6.7	14.3	39	19.2	4.5	166	268
Z802310 - 1 x 100 m	KLA 16-10 (400)	10.0	17.3	48	23.0	6.7	251	402

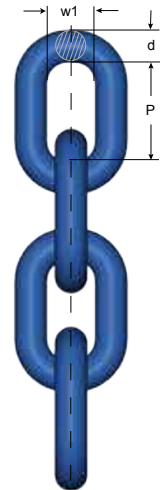

Classic Chain KLB/KLU, Grade 8

Short link lifting chain

Heat treatment

Hardened and tempered.

Surface treatment

Painted black (KLB)
Painted yellow (KLU)

Fulfills the requirements in:

EN 818-2:2008, AS 2321:2014,
ASTM A391/A 391M-07 (2012)

Art. no. Box	Code	WLL tonnes*	d nom.	p	w1	Weight kg/m	MPF kN	Breaking force kN
Z802174 - 1 x 200 m	KLB 6-8E	1.12	6	18	8.5	0.8	28.3	45.2
Z802175 - 1 x 200 m	KLB 7-8E	1.57	7	21	10.0	1.1	38.5	62
Z802176 - 1 x 200 m	KLB 8-8E	2.0	8	24	11.0	1.4	50.3	80.6
Z802156 - 1 x 100 m	KLB 10-8E	3.2	10	30	14.0	2.3	79	130
Z802157 - 1 x 100 m	KLB 13-8E	5.4	13	39	17.7	3.8	133	214
Z802177 - 1 x 100 m	KLB 16-8E	8.2	16	48	21.9	5.6	201	322
Z801203 - 1 x 100 m	KLB 19-8E	11.6	19	57	27.0	7.8	284	457
Z801228 - 1 x 50 m	KLB 22-8E	15.5	22	66	29.5	10.6	380	610
Z801231 - 1 x 50 m	KLB 26-8E	21.6	26	78	35.0	14.8	531	850
Z801232 - 1 x 25 m	KLB 32-8E	32.8	32	96	41.6	21.6	804	1300

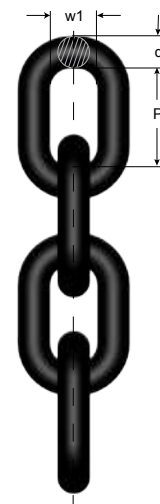

5

Galvanized Chain KLZ, Grade 8

Short link lifting chain

Heat treatment

Hardened and tempered.

Surface treatment

Hot Dip Galvanized

Fulfills the requirements in:

EN 818-2:2008 (material dim. \varnothing +10%)
ISO 1461:2009
ASTM A391/A391M-07 2012 (material dim. \varnothing +10%)

Art. no.	Code	WLL tonnes*	d nom.	p	w1	Weight kg	MPF kN	Breaking force kN	Delivery length
ZG802306	KLZ-6-8 HDG	1.12	6.6	18	8.9	1.0	36.8	45.2	1 x 100 m
ZG802307	KLZ-8-8 HDG	2.0	8.8	24	11.2	1.7	63.0	80.6	1 x 100 m
ZG802308	KLZ-10-8 HDG	3.2	11.0	30	14.4	2.6	98.8	130	1 x 100 m
ZG802309	KLZ-13-8 HDG	5.4	14.3	39	19.2	4.5	166	214	1 x 100 m
ZG802310	KLZ-16-8 HDG	8.2	17.3	48	23.0	6.7	251	322	1 x 100 m



Short Link Chain KLFU, Grade 8

Not for lifting purposes

Heat treatment
Hardened and tempered,
Stress relieved

Surface treatment
Painted yellow

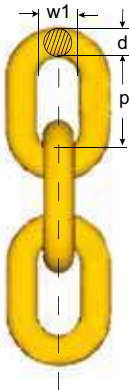

Art. no.	Code	d. nom.	p	w1	Weight kg/m	Min. breaking load tonnes	Delivery length
Z802330	KLFU-10-8	10	30	14.0	2.2	12.6	1 x 100 m
Z802331	KLFU-13-8	13	39	17.6	3.7	21.4	1 x 100 m
Z801146	KLFU-16-8	16	48	21.5	5.8	32.2	1 x 100 m
Z327377	KLFU-19-8	19	57	27.0	8.0	45.4	1 x 100 m
Z327385	KLFU-22-8	22	66	30.0	11.0	61.0	1 x 50 m
Z801505	KLFU-26-8	26	78	35.0	14.8	86.0	1 x 50 m

Mid-link Chain MLFU, Grade 8

Not for lifting purposes

Heat treatment
Hardened and tempered,
Stress relieved

Surface treatment
Painted yellow

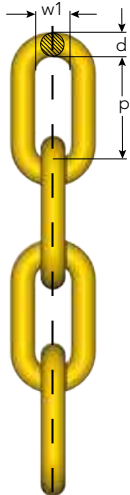

Art. no.	Code	d. nom.	p	w1	Weight kg/m	Min. breaking load tonnes	Delivery length
Z802332	MLFU-10-8	10	40	14.4	2.0	12.6	1 x 100 m
Z802333	MLFU-13-8	13	55	20.2	3.3	21.4	1 x 100 m
Z800564	MLFU-16-8	16	65	20.5	5.0	32.2	1 x 100 m
Z800476	MLFU-19-8	19	75	29.0	7.1	45.4	1 x 100 m
Z800661	MLFU-22-8	22	88	30.0	9.4	61.0	1 x 50 m
Z801770	MFLU-26-8	26	91	34.0	13.9	86.0	1 x 50 m

Long Link Chain LLU, Grade 8

Not for lifting purposes

Heat treatment
Hardened and tempered,
Stress relieved

Surface treatment
Painted yellow

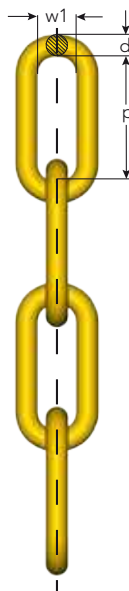

Art. no.	Code	d. nom.	p	w1	Weight kg/m	Min. breaking load tonnes	Delivery length
Z801935	LLU-11-8	11	64	18.5	2.1	15.4	4 x 100 m
Z801936	LLU-13-8	13	80	21.1	2.9	21.4	3 x 100 m
Z802160	LLU-16-8	16	100	27.0	4.6	32.2	1 x 100 m
Z601983	LLU-19-8	19	100	27.0	6.5	45.4	1 x 100 m
Z700526	LLU-22-8	22	120	35.0	8.7	61.0	1 x 50 m

Short Link Chain KLFZ, Grade 7

Not for lifting purposes

Heat treatment
Hardened and tempered

Surface treatment
Hot Dip Galvanized (HDG)

Art. No	Code	d nom.	p	w1	Min. breaking load tonnes	Weight kg/m	Delivery length
Z800666	KLFZ-10-7	10	30	14.0	11	2.2	1 x 100 m
Z802329	KLFZ-13-7	13	39	17.2	18	3.7	1 x 100 m
Z801644	KLFZ-16-7	16	48	21.5	28	5.8	1 x 100 m
Z801409	KLFZ-17-7	17	48	23.2	30	6.4	1 x 100 m
Z801407	KLFZ-19-7	19	57	27.0	40	8.0	1 x 100 m

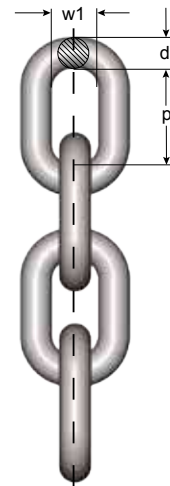

Fulfills requirements in: EN 1461:2009 (Average surface thickness 85 µm)

Mid-link Chain MLFZ, Grade 7

Not for lifting purposes

Heat treatment
Hardened and tempered

Surface treatment
Hot Dip Galvanized (HDG)

Art. No	Code	d nom.	p	w1	Min. breaking load tonnes	Weight kg/m	Delivery length
Z802455	MLFZ 10-6**	10	40	14.4	10	2.0	1 x 100 m
Z802335	MLFZ-13-7	13	55	20.2	18	3.3	1 x 100 m
Z801645	MLFZ-16-7	16	65	20.5	26.2	5.0	1 x 100 m
Z801477	MLFZ-19-7	19	75	29.0	37	7.1	1 x 100 m

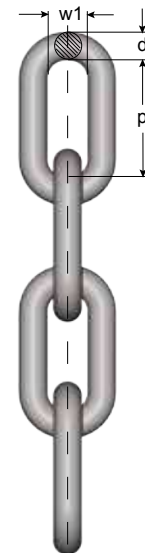

Fulfills requirements in: EN 1461:2009 (Average surface thickness 85 µm)

** Average surface thickness 70 µm

Long Link Chain LLZ, Grade 6

Not for lifting purposes

Heat treatment
Hardened and tempered

Surface treatment
Hot Dip Galvanized (HDG)

Art. No	Code	d nom.	p	w1	Min. breaking load tonnes	Weight kg/m	Delivery length
Z802454	LLZ-11-6**	11	64	18.5	11.6	2.1	4 x 100 m
Z800682	LLZ-13-6	13	80	21.1	16.3	2.9	3 x 100 m
Z802207	LLZ-13-6	13	80	21.1	16.3	2.9	1 x 229,5 m
Z801567	LLZ-16-6	16	100	28	24.7	4.6	1 x 100 m
GS1073	LLZ-16-6	16	100	28	24.7	4.6	1 x 200 m
Z801458	LLZ-19-6	19	100	28	34.8	6.5	1 x 120 m
Z801887	LLZ-22-6	22	120	36	46.6	8.7	1 x 50 m
Z802447	LLZ-25-6	25	140	39	60.0	12.0	1 x 50 m
Z802449	LLZ-28-6	28	150	39	75.3	14.9	1 x 50 m
Z802451	LLZ-32-6	32	170	44	98.3	19.0	1 x 50 m

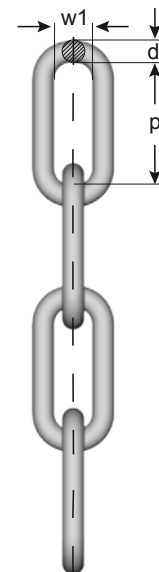

Fulfills requirements in: EN 1461:2009 (Average surface thickness 85 µm)

** Average surface thickness 70 µm

Technical information

Chain manufacturing - Quality and strength requirements

Chains are divided into grades based on minimum nominal breaking stress.

Chain Grade	Surface treatment	Code	Minimum breaking stress N/mm ²	Load factors			Typical use
				WLL	MPF	Breaking force	
8	Yellow U	KL	800	1	2.5	4	General lifting (KL), Container lashing (LL). Extra heavy towing (ML), Lashing (KL, LL). Fishing (KL, ML, LL)
	Black B	ML	800	-	1	4	
	Hot Dipped Galvanized Z	LL	800	-	1	4	
10	Blue A	KL	1000	1	2.5	4	General lifting

Testing and quality control GrabiQ & Classic Chain (Grade 10 & 8)

In each step of the manufacturing of the chain, our systematic quality monitoring will ensure the highest safety and the longest life span in the product. Here are some especially important aspects of quality:

Material

The incoming material is supplied with test certificates only from qualified manufacturers and according to our stated material specifications.

Manufacturing

During forming and welding, the operators continuously control that the links meet the specified dimensions both before and after welding.

Single link samples are continuously mandrel tested on the weld. Shape, dimensions and deburring are then inspected visually.

Sample lengths are heat treated and then destruction load tested. Following these tests, the chain is heat treated.

Hardening and tempering is carried out continuously in computer controlled induction furnaces with regular samplings.

Proof force

The entire chain is test loaded. The manufacturing proof force for short link chain is 2.5 times the permitted working load limit. This gives the chain high safety in use. The chain is then visually inspected and cut into delivery lengths. A sample is taken from every length and tested to destruction. Dimensions and shape are also checked. All results are documented.

Marking and traceability

The international standards for lifting chain require that the chain is marked with Grade and Manufacturers ID. On our chain we stamp "SWE - CG - 10G - - 4", where the "H" and the "4" is the combination for the traceability code. In case of the unlikely event of chain failure, we can trace the specific chain link back to the very batch and raw material as well as the year and place of manufacture. Each individual delivery length also has its unique batch number.

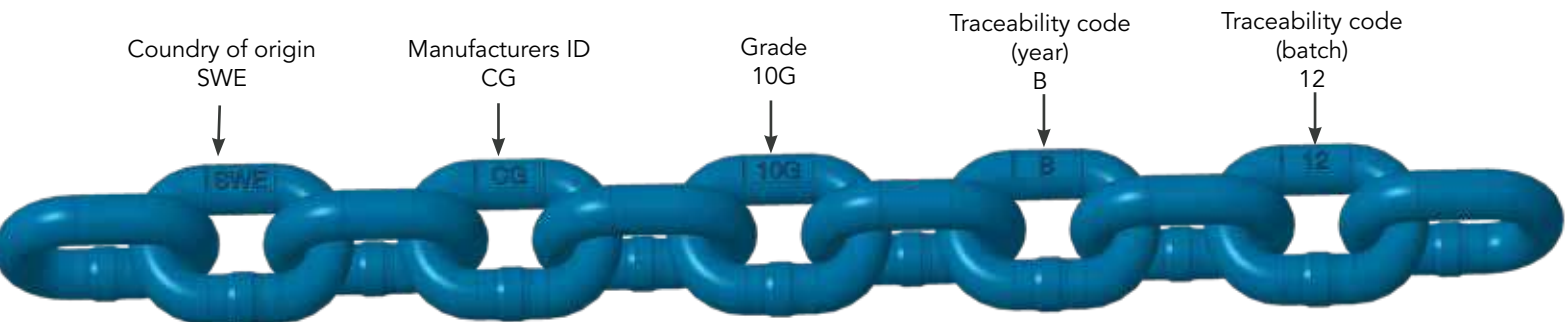

Use

- Never lift with a twisted chain.
- Use shortening hooks, knotting is not allowed.
- Use edge protectors to prevent sharp edges from damaging the chain.

Maintenance

Periodic thorough examination must be carried out at least every 12 months or more frequently according to local statutory regulations, type of use and past experience.

1. Overloaded chain slings must be taken out of service.
2. Chain and components including load pins which have been damaged, deformed, elongated, bent or showing signs of cracks or gouges shall be replaced. Carefully grind away small nicks and burrs.
3. Additional testing by magnetic particle inspection and/or proof loading at max. 2 x WLL may be carried out. The wear of the chain and component shall in no place exceed 10% of the original dimensions.
4. The chain link wear - max. 10% - is defined as the reduction of the mean diameter measured in two directions.

Severe environment

Chain and components must not be used in alkaline (>pH10) or acidic conditions (<pH6). Comprehensive and regular examination must be carried out when used in severe or corrosive inducing environments. In uncertain situations consult your Gunnebo Industries dealer.

Extreme temperature conditions

The in service temperature effects the WLL as following :

Temperature (°C)	Reduction of WLL			
	Grade 10 chain (400)	Grade 10 chain (200)	Grade 10 components	Grade 8 chain & components
-40 to +200 °C	0 %	0 %	0 %	0 %
+200 to +300 °C	10 %	Not allowed	10 %	10 %
+300 to +400 °C	25 %	Not allowed	25 %	25 %

After short heat exposure, maximum one hour, the sling reverts to its full capacity. Upon return to normal temperature, the sling reverts to its full capacity within the above temperature range. Chain slings should not be used above or below these temperatures.

For chain grade 10 the maximum in service temperature is 200° C.

Definitions

Proof force:

Each individual chain link is tested to the Manufacturing Proof Force (MPF) level before delivery. The MPF level is 2.5 times the WLL, equal to 62.5% of the Minimum Breaking Force.

Breaking force (BF):

The highest static force a chain is exposed to during test loading before breaking.

Working load limit (WLL):

The maximum permitted load on a lifting chain under normal (vertical) lifting conditions.

Total ultimate elongation:

The elongation of the test item, relative to the original length, at the moment of breaking.

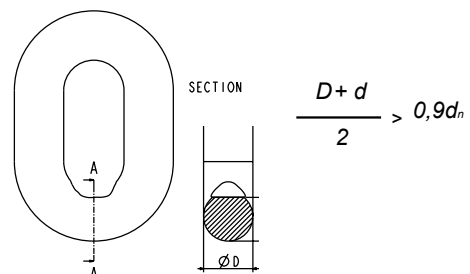

Lashing Components

Chain Tensioner • Other Lashing Products



GUNNEBO
Industries

Lashing Components

Chain Tensioner GT	6:2 - 6:4
Chain	6:4
Midgrab chain shortener MIG	6:4
Grab Hook GG with Locking Pin	6:5
Sling Hook	6:5
Safety Hook	6:5
Weldable Lifting Point	6:5
Screw-on Lifting Point	6:5

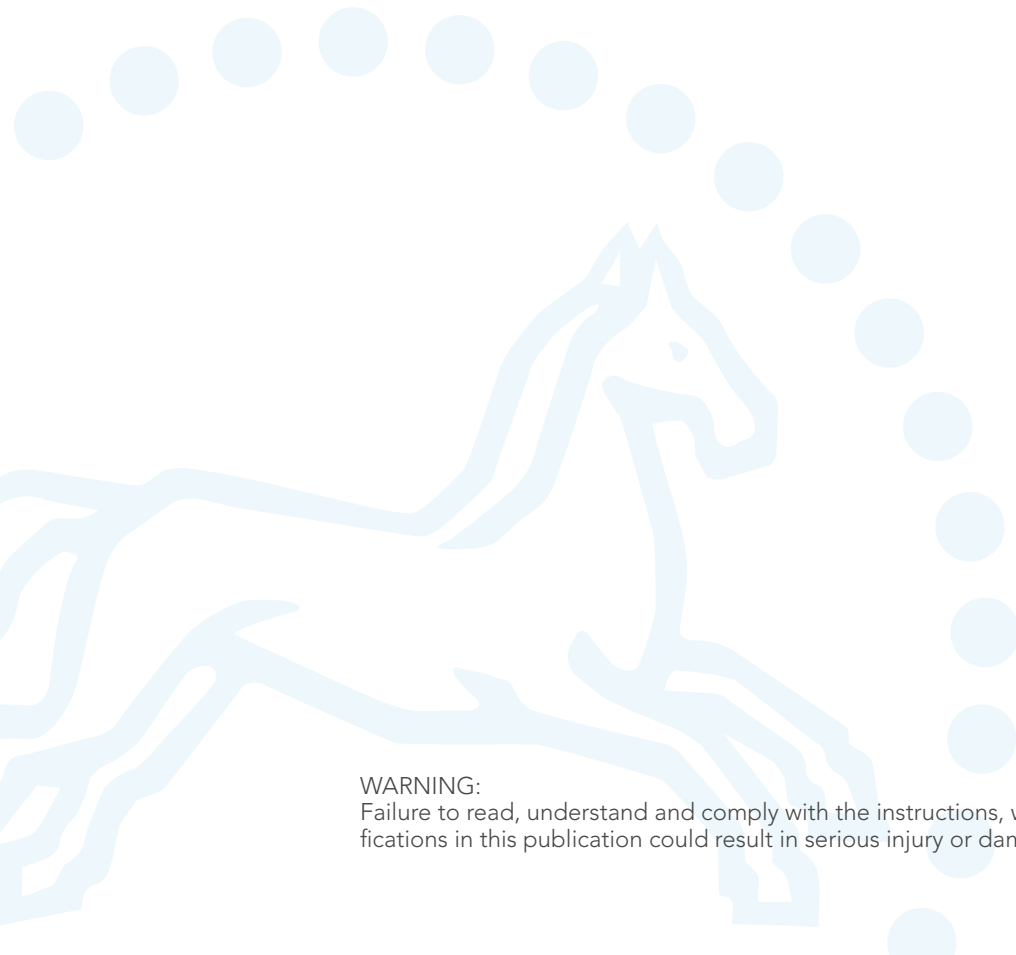

WARNING:
Failure to read, understand and comply with the instructions, working load limits and specifications in this publication could result in serious injury or damage to property.

Chain Tensioner GT

The chain tensioner from Gunnebo Industries, GT, is integral in one set. It is made of high strength Grade 10 material and the ratchet handle contributes to a fast and ergonomic lashing procedure. The GT is fitted with safety pins to prevent unintended release of the threaded end fittings.

GT has 25% increased Lashing Capacity (LC) compared to Grade 8 lashings and high Standard Tension force (STF) thanks to the unique ratchet handle .

Our chain tensioner is designed to be compatible with the GrabiQ product range, enabling the choice of robust end-hooks with latches. Can also be provided as approved for lifting purposes.



Unique benefits with our Chain Tensioner

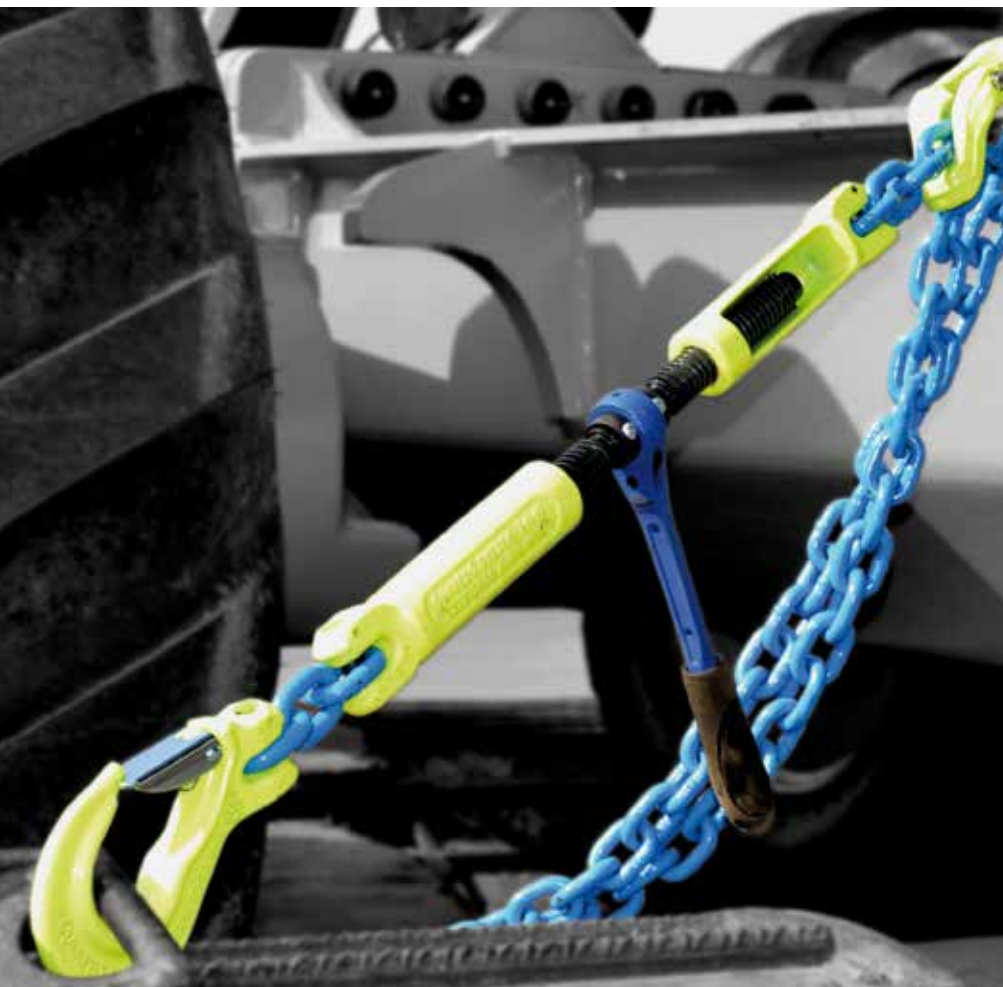

Short handle

- Fully protected ratched mechanism with 8 steps per 90 degree pull, enabling use in very narrow spaces.
- Easy to change direction.
- The rubber handle decreases the risk of slipping and is convenient in cold climates.

Open design

- For easier and faster cleaning and lubrication.
- Allows dirt to fall through instead of building up.
- Two drain holes in the body prevent water residue.

Trapezoidal thread

- Makes the thread less sensitive to dirt and particles.
- Low-friction treated for trouble free operation.
- Makes lashing faster.
- Safety pins prevents unintended unwinding.

Chain Lashing System

Gunnebo Industries offers a complete chain lashing system approved according to EN 12195-3. The system has been developed with focus on the user's needs and working environment, and with safety as highest priority. The unique Midgrab chain shortener saves valuable time and effort, and is a natural part of an efficient and effective chain lashing system.

GT Chain Lashing System offers 25% increased Lashing Capacity (LC) compared to Grade 8 lashings.

End fitting

Lashing hooks in grade 10, such as the EGKN Sling Hook with a heavy duty latch or the GBK Griplatch Safety Hook. Marked with positive indication of the manufacturer, product designation, size, batch number and grade.

ID-tag

The ID-tag must state the lashing standard, capacity, tension force, traceability and name of manufacturer. It must also clearly say that the set is for lashing only, lifting is prohibited

Shortening function

The Midgrab offers instant mounting on any part of the chain, with the ability to shorten the chain in either direction. It is designed to prevent the chain from disengaging. Marked with positive indication of the manufacturer, product designation, size, batch number and grade.

Chain

Gunnebo Industries high tensile short link chain, grade 10 = 1000 N/mm² type KLA-10-10, LC = 80 kN. Surface treatment: Powder coated. ID-marking of the chain: 10G

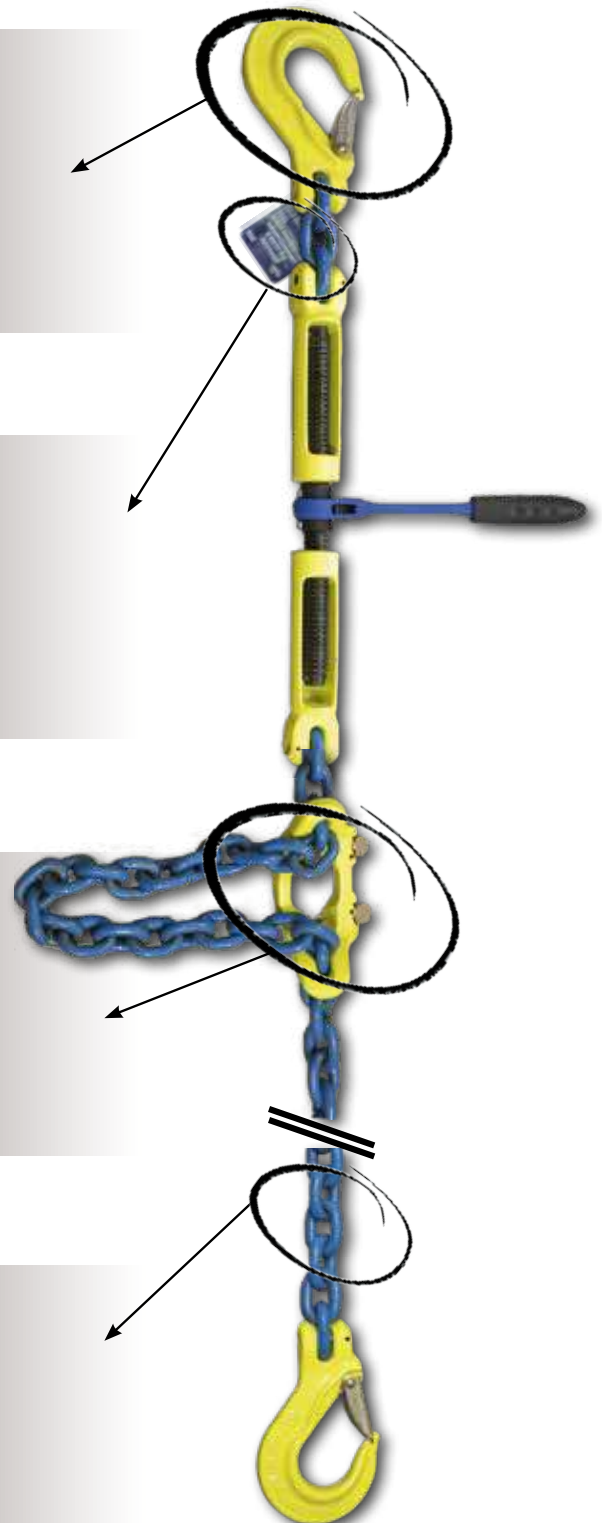

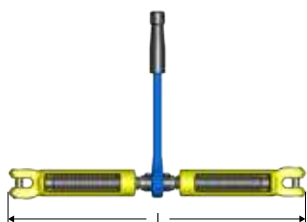

Chain Tensioner GT

Art. no	Model	Lashing capacity (kN)	STF (daN)	L = Min. length (mm)	L = Max. length (mm)	Weight kg
Z101336	GT-8-10	50	2800	400	600	3.3
Z101337	GT-10-10	80	2800	400	600	3.3

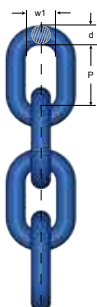

Chain, GrabiQ Grade 10 (200)

Short link, KL

Art. no.	Code	WLL tonnes	Lashing capacity (kN)	d nom. mm	P mm	w1 mm	Weight kg/m	MPF kN
Z802301	KLA-8-10	2.6	51	8	24	11.0	1.4	63
Z802302	KLA-10-10	4.0	80	10	30	14	2.3	100

Fulfills the requirements in ASTM A973/A973M-07(2012) EN 818+2:2008 (WLL +25%, reduced temperature range).

See our full range of chain in chapter 5

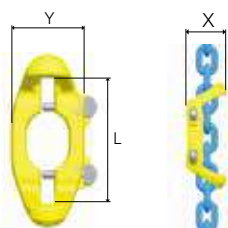

Midgrab MIG with locking pins

Art. no.	Code	WLL tonnes	Lashing capacity (kN)	L	X	Y	Weight kg
B14303	MIG CC-8-10	2.6	51	95	50	60	0.7
B14313	MIG CC-10-10	4.0	80	125	70	77	1.1

Complete set for Lashing GT
with chain, hooks and MIG Shortener



Lashing GT
with GG hooks



Lashing Chain GrabiQ
with hooks in both ends



Chain Tensioner GT for lifting see page 2:21

Grab Hook GG with Locking Pin

Clevis shortening hook with locking pin for extra safety. No reduction of working load limit, thanks to supporting cradle lugs on either side of hook to prevent chain link deformation.

Art. no.	Code	WLL tonnes*	Lashing capacity (kN)	L	B	Weight kg
B14971	GG-8-10 LP	2.6	51	57	10	0.4
B14972	GG-10-10 LP	4.0	78	77	12	0.9
B14973	GG-13-10 LP	6.8	133	97	16	1.9
B14974	GG-16-10 LP	10.3	202	114	20	3.2

Fulfills requirements in: EN 1677:2008 (WLL +25%), ASTM A952/A952M and AS 3776:2015.

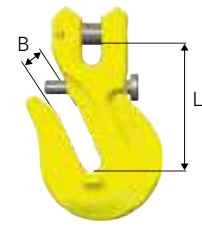

Sling Hook EGKN

Sling hook with latch.

Art. no.	Code	WLL tonnes	Lashing capacity (kN)	L	B	G	H	Weight kg
B14461	EGKN-8-10	2.6	51	95	28	17	23	0.5
B14462	EGKN-10-10	4.0	78	121	35	23	31	1

Fulfills requirements in: EN 1677:2008 (WLL +25%), ASTM A952/A952M and AS 3776:2015.

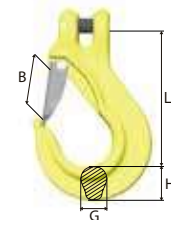

Safety Hook GBK

Safety hook with clevis connector and grab latch.

Art. no.	Code	WLL tonnes	Lashing capacity (kN)	L	B	G	H	Weight kg
Z100759	GBK-8-10	2.6	51	119	36	20	22	0.8
Z100760	GBK-10-10	4.0	78	150	47	22	29	1.4

Fulfills requirements in: EN 1677:2008 (WLL +25%), ASTM A952/A952M and AS 3776:2015.

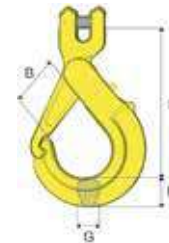

Weldable Lifting Point WLP

Art. no.	Code	WLL tonnes*	Lashing capacity (kN)	B	D	G	L	R	X	Weight kg
Z7009001	WLP-2.5T	2.5	49	50	14	27	53	24	95	0.5
Z7009011	WLP-4T	4.0	78	58	17	34	48	29	97	0.8
Z7009021	WLP-7T	7.0	137	64	22	41	73	33	135	1.8
Z7009031	WLP-10T	10.0	196	65	27	52	73	38	152	3.4
Z7009041	WLP-16T	16.0	313	90	32	66	105	50	203	8.5

Supplied with spring for stay up function.

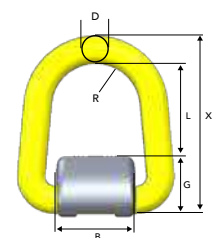

Screw-on Lifting Point SLP

Art. no.	Code	WLL tonnes*	Lashing capacity (kN)	B	C	H	L	M	X	Bolt protrusion	Weight kg
Z7009881	SLP-1T	1.0	19	50	72	98	54	M14	139	25	0.8
Z7009871	SLP-3T	3.0	58	58	84	114	49	M16	144	28	1.3
Z7009861	SLP-5T	5.0	98	64	116	160	71	M20	203	34	2.6

Supplied with spring for stay up function.
Bolt according to: ISO 898-1 Class 10.9.

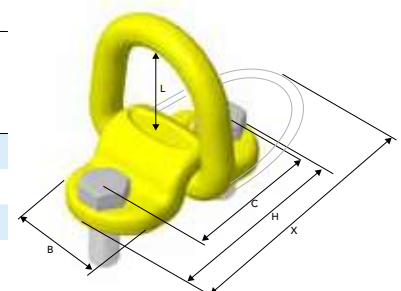



GUNNEBO
Industries

gunneboindustries.com



the Crosby group[®]

The Crosby Group is a global leader in the innovation, manufacturing and distribution of products and services used to make lifting and load securement safer and more efficient, with premier brands such as Crosby, Gunnebo Industries, Crosby Straightpoint, Acco, McKissick, Crosby Feubo, Trawlex, Lebus, and CrosbyIP.

With global engineering, manufacturing, distribution and operations, the company provides a broad range of products and solutions for the most demanding applications with uncompromising quality that exceed industry standards.

The Crosby Group, with its team members around the world, provides an unparalleled training program supported by industry experience dating back hundreds of years, creating safer work environments for people everywhere.